

ANTIGUA TECHNICAL SPECIFICATIONS



2019 Version 1.7

The **ShutterShop**

ANTIGUA SPECIFICATIONS CONTENTS

To go to required section click [coloured headings](#) below

Section 1			
Introduction	3		
Specifications	4		
Colours	5		
Section 2			
Installation Styles	6		
Full Height			
Cafe Style			
Tier on Tier			
Tracked Shutters			
Unsupported Shutters			
Section 3			
Framing styles	7		
Beaded			
Bullnose L			
Insert L			
Plain L			
Tiara Z	8		
Crown Z			
Beaded Z	9		
Bullnose Z			
Ridge Deco			
Camber Deco			
Serrate Z			
Insert Hang Strip			
Cover Strip	11		
T Posts			
L/Z			
Deco			
Insert T			
Corner Posts			
L/Z			
Deco			
Bay Posts	12		
L/Z			
Deco			
Battens	12		
Section 4			
Panel details	13		
Stile			
Rails	14		
Louvres	15		
Louvre pin			
Tilt Rods			
Standard tilt rod			
Silent tilt rod			
Offset tilt rod			
Offset tilt rod for Multi-fold Shutters			
Section 5			
Room Darkening	17		
Section 6			
Hardware	23		
Bolts & Ring Pulls	26		
Panel Configurations	29		
Section 7			
Sizing & Measuring	31		
Order Size Definition			
Overall Panel size (OP)			
Overall Dimension of frame (OD)			
Tolerances	34		
Mounting Type			

1. ANTIGUA INTRODUCTION

The Antigua is our entry-level product manufactured in MDF covered in an extruded polypropylene coating, offering exactly the same levels of quality but with reduced colour options and installation capabilities. Antigua is available in 9 painted colours and due to its weight is not suitable for larger unsupported window installations. The maximum number of panels that can be hinged together is 2.

Aesthetics:

Manufactured using a patented polymer coating the shutters are extremely durable and easy to maintain. The Antigua shutters have a slight shinier look and a slight orange peel finish due to the polymer coating. Painted shutters have a flatter finish.

Frames: Limited range of frames available.

Stiles:

Please note the stiles are manufactured in a beaded and plain stile.

Louvres:

Antigua is available in 47mm, 63mm, 76mm, 89mm, 114mm, elliptical louvres.

Colour palette:

There are a total of 9 colour shades available. Custom colour is not available.



ANTIGUA SPECIFICATIONS

PANEL SIZE LIMITATIONS

Louvre Size	Width			Height		
	Minimum	Maximum		Minimum	Maximum	Mid rail Required if
		Single hung	Bi-fold hinged shutter/ Multi-fold with Top and Bottom track			
47mm	152mm	600mm	600mm	250mm	3000mm	H>1879mm
63mm	152mm	750mm		250mm	3000mm	H>1879mm
76mm	152mm	750mm		250mm	3000mm	H>1879mm
89mm	152mm	750mm		250mm	3000mm	H>1879mm
114mm	152mm	750mm		250mm	3000mm	H>1879mm

SPECIFICATIONS

Material	MDF
Panel Weight per sqm	8.93 - 10.23 kg
Paint Colours	9
Stain Colours	✗
Custom Colours available	✗
Louvre sizes	47mm 63mm 89mm 76mm 114mm
Max single panel width	600mm : 47mm 750mm : REST
Max bi-fold panel width	600mm : ALL
Max number of panels hinged together	2 (1 if a doorway)
Max and min panel heights. (For panel height over 2500mm, it is suggested using 50.8mm or 57mm stile to aid structural integrity).	3000mm 250mm
Solid Panels available	✗
Special shapes	✗
Custom Bay Post angles	✓
Stile Type	Beaded or Plain
Fixed Louvres	✓

This material belongs to ShutterShop and copying or reproduction in whole or in part is strictly prohibited. We reserve the right to alter specifications without prior notice.

COLOURS

Please note. Colours may vary slightly between dye lots. Shutters for the same installation should be ordered together to avoid variations in colour. Colours may vary slightly from colour samples. For this reason, colour samples should be updated annually.

COLOUR OPTIONS

ANTIGUA PAINT OPTIONS (5 COLOURS)				
Colour ID	Colour Name		Default Hinge Colour	Optional Hinge Colour
001	Pure White		Pure White	1. Pure White 2. White 3. Pearl 4. Bisque 5. Antique-Brass 6. Bright-Bass 7. Stainless 8. Black 9. Nickel-Plated 10. Brushed Nickel-Plated
003	Silk White		White	
006	Pearl		Pearl	
012	Crisp Linen		Bisque	
019	String		Bisque	
032	Sea Mist		Nickel Plated	
049	Stone Grey		Nickel Plated	
051	Brown Grey		Nickel Plated	
080	Taupe Grey		Nickel Plated	

2. INSTALLATION STYLES



FULL HEIGHT
Shutter covering the full height of aperture.



TRACKED SHUTTERS

Bi-Fold
Shutters suspended from a top track hinged together in a bi-fold configuration to allow them to be folded back to the end of the track at 90° or 180°. Suitable for use with patio doors, wardrobes or as a room divider. May be specified and fitted with or without side frames.

By-Pass
Shutters suspended from a top track. Panels slide behind or in front of one another to open or close. Suitable for use with patio doors, room dividers and wardrobes. May be specified and fitted with or without side frames.

* Refer to the separate track specifications for further details.

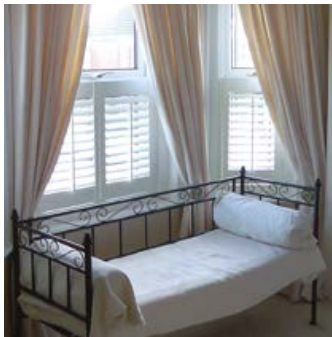

CAFE STYLE
Shutter covering only the lower portion of aperture providing privacy and light control but leaving the top portion un-shuttered to maximise light, where privacy is not required.



SHUTTERS USED AS DOORS

In situations where shutters will be used for a door application which does not have support underneath the panels, the customer must inform the Shutter Shop when placing the order



ROOF SHUTTERS
Would not be supplied or covered under warranty.
Please refer to Fiji specifications for roof details.

Panel Configuration

L, R, LR	LL, RR, LLRR
Manufactured with warranty waived	Only available with a tracked installation. Not covered by warranty.



TIER ON TIER
Shutter is split into two halves so the top and bottom panels can be independently operated / opened fully. The standard gap between top tier and bottom tier is 2.5mm. For multi-fold tier on tier shutters only 3 or less multi-fold panels are within warranty.

Please note:

1. The factory will add extra hinges to support the panels
2. The factory will add a larger and stronger top and bottom rail. This will reduce the risk of panels sagging.

3. FRAMING STYLES

BEADED

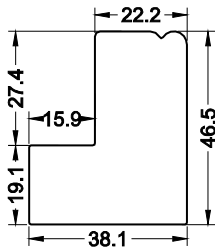

46mm

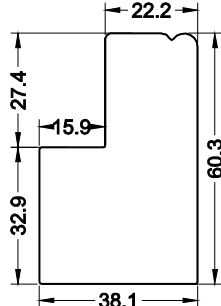

60mm

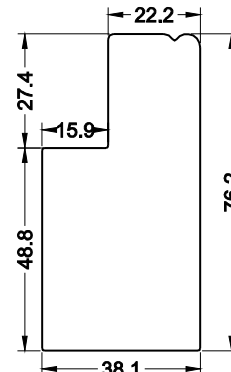

76mm

INSERT L

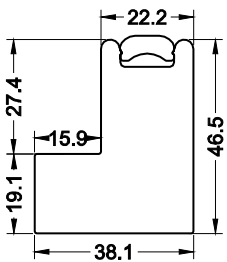

46mm

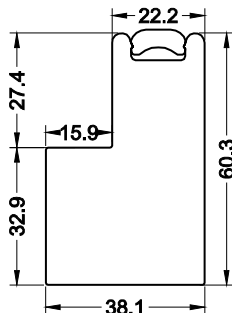

60mm

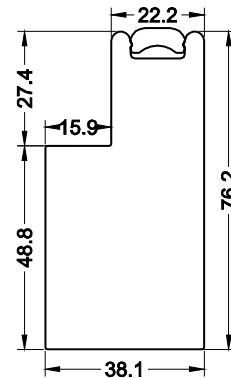

76mm

PLAIN DEEP L W/INSERT

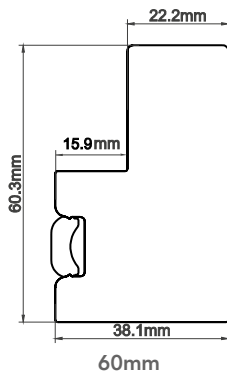

60mm

PLAIN L FRAME

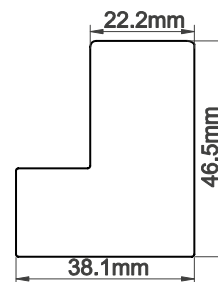

46mm

FRAMING STYLES

TIARA Z FRAME

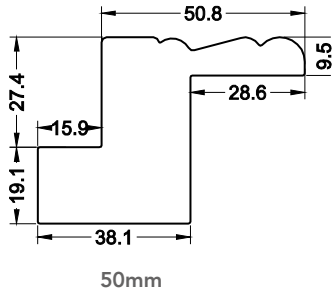

TIARA Z SILL PLATE

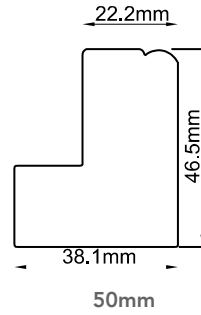

CROWN Z FRAME

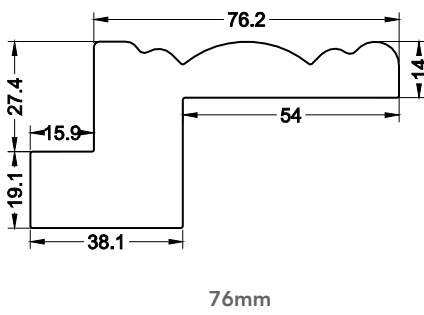

CROWN Z SILL PLATE

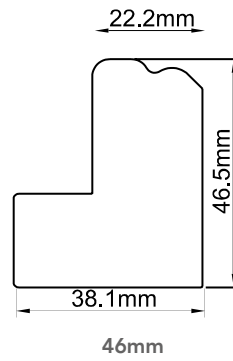

MISSION FRAME

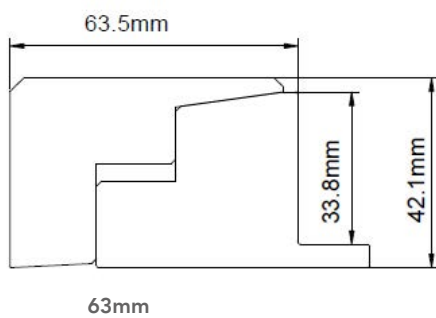

BEADED Z

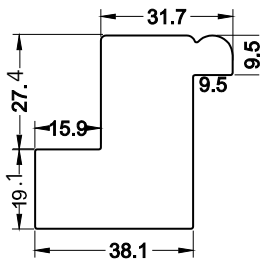

31mm

BEADED Z SILL PLATE

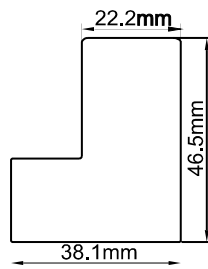

BULLNOSE Z FRAME

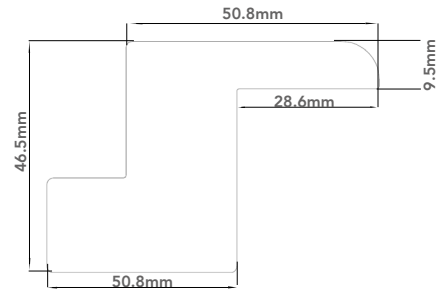

50mm

BULLNOSE Z SILL PLATE

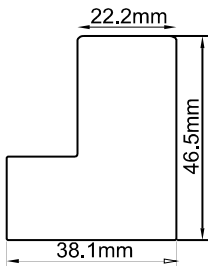

BULLNOSE Z

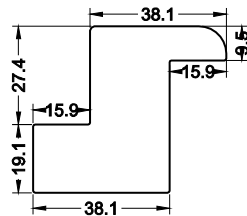

38mm

BULLNOSE Z DEEP W/INSERT

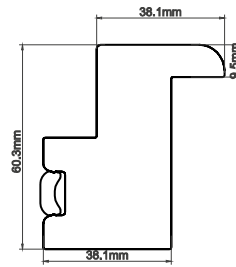

38mm

RIDGE DECO FRAME

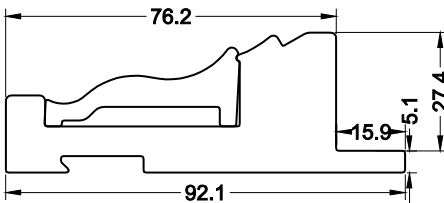

76mm

RIDGE DECO SILL PLATE

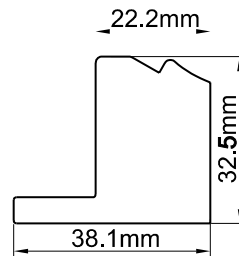

SERRATE Z FRAME

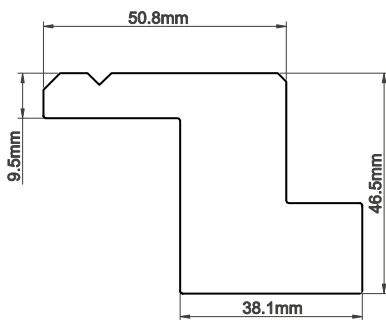

50mm

SERRATE Z SILL PLATE

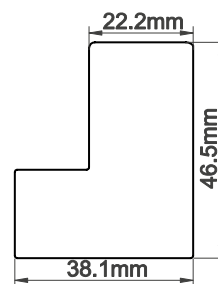

46mm

CAMBER DECO FRAME

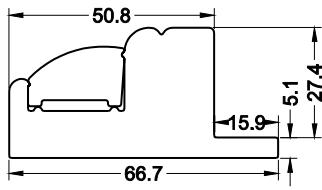

50mm

CAMBER DECO SILL PLATE

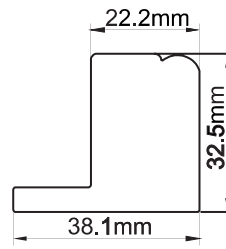

DOUBLE INSERT L FRAME & F FRAME

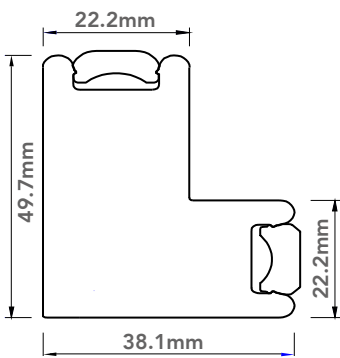

Double Insert L Frame
50mm

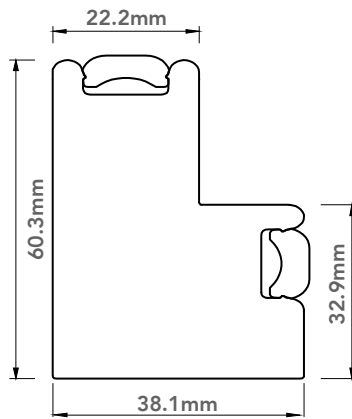

Double Insert L Frame
60mm

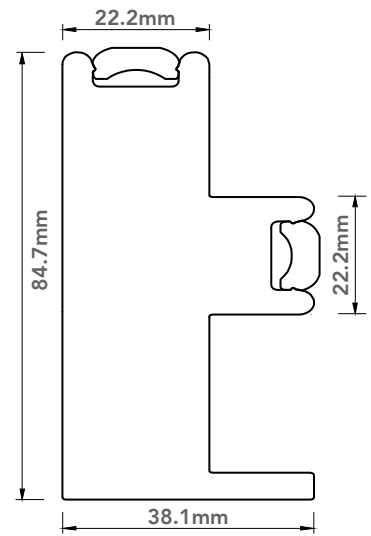

Double Insert F Frame
84mm

N.B: No screw holes will be pre-drilled for Double Insert L Frame, but 76.2mm screws will be supplied loose in the hardware box.

HANG STRIP WITH INSERT

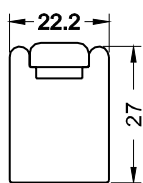

27mm

This material belongs to Shuttershop and copying or reproduction in whole or in part is strictly prohibited. We reserve the right to alter specifications without prior notice.

COVER STRIP*

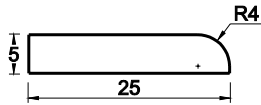

25mm

COVER STRIP*

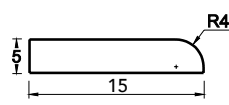

15mm

VINTAGE HANG STRIP

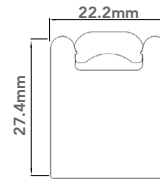

22mm

* Cover strips are made in wood.

T-POST

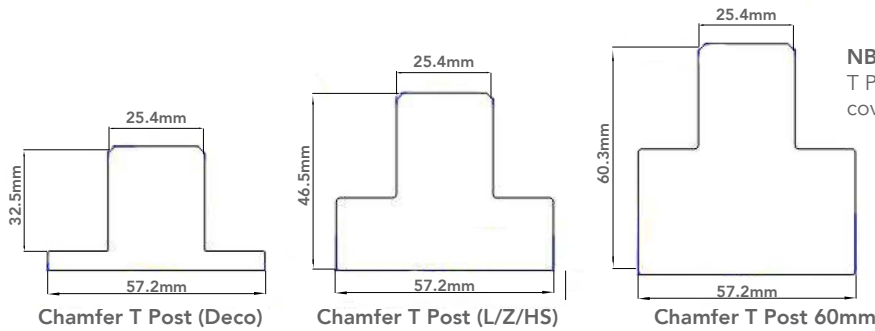

NB. Please note that horizontal T Posts over 1219mm are not covered by warranty.

T-POST W/INSERT

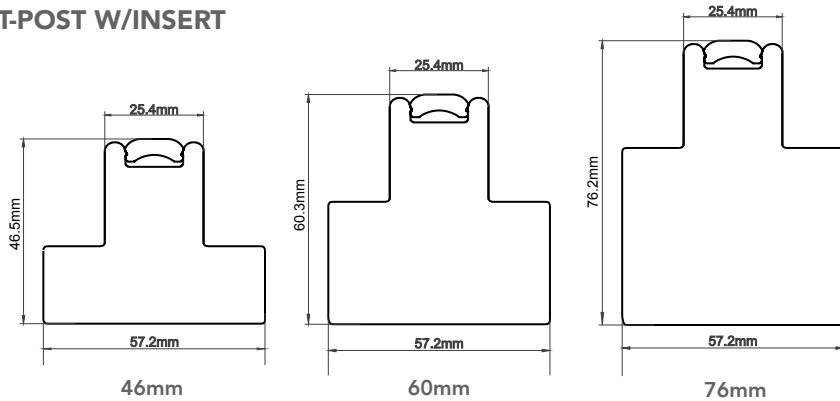

NB. Please note that horizontal T Posts over 1219mm are not covered by warranty.

CORNER POST

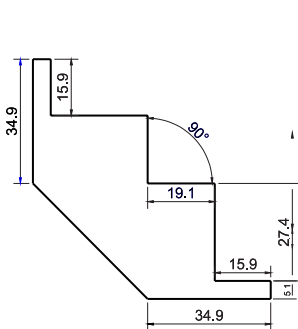

(Deco Frame)
32mm

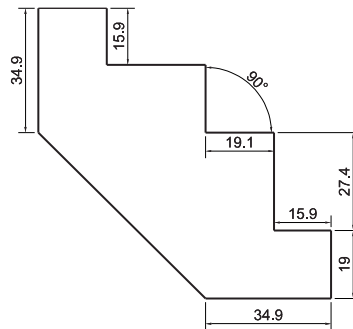

(L/Z/HS Frame)
46mm

BAY POSTS

Additional custom angles are also available. Custom angle bay posts cannot have the insert strip.

[BACK TO MENU](#)

135° angle

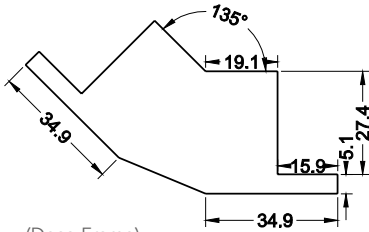

(Deco Frame)

32mm

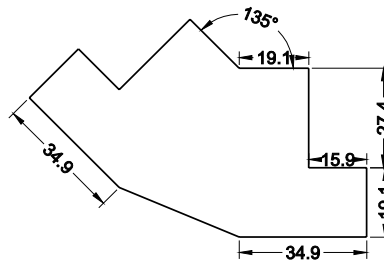

(L/Z/HS Frame)

46mm

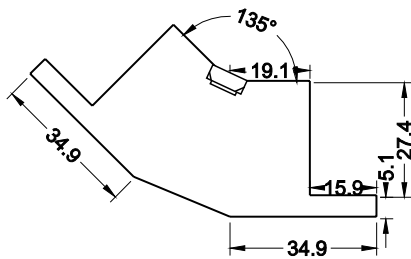

(Deco Frame)

32mm with insert

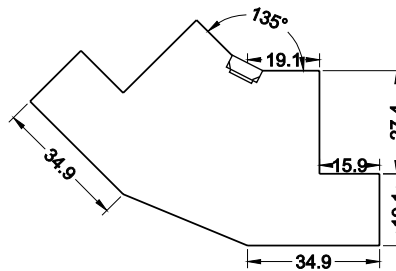

(L/Z/HS Frame)

46mm with insert

Frames split when the frames length exceed the below limitation.

When frame lengths (including shutter frames, batten, fascia, header and tracks for track system) exceed the below limitation, then the frames will be split as the below chart describes. Please review the chart for reference.

Shipping Method	Program	Frame Length (L) (mm)
Standard shipping	all programs	3630<L≤7260 (2 sections)/ L>7260 (3 sections)
Airfreight	all programs	3048<L≤6096 (2 sections)/ 6096<L≤9144 (3 sections)

BATTENS

Battens can be butt-jointed as per the drawings below:

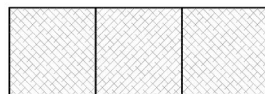
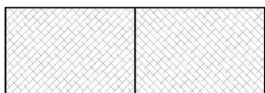

Battens and Panels identification: The order number will be stamped on the bottom of each panel and one end of each corresponding batten to identify which one belongs to which item, when ordering Cuba, Fiji or Sumatra.

Standard sizes:

Stock Battens are available in the following sizes in all materials

Made of Wood

2.5mm x 27mm
3mm x 15mm
3mm x 20mm
3mm x 30mm
3mm x 60mm
5mm x 45mm
5mm x 63.5mm
30mm x 40mm
40mm x 40mm

Coated with PP

25mm x 30mm
25mm x 40mm
5mm x 38mm
10mm x 38mm
15mm x 38mm
20mm x 38mm
25mm x 38mm
30mm x 38mm
35mm x 38mm
40mm x 38mm

Minimum charge one linear meter per batten

Build-out (Extension)

- For L/Z/Deco/Hang Strip Frame including T-Post, we will pre-attach the build-out of which the thickness is less than 50.8mm (including 50.8mm) by default;
- For L/Z/Deco/Hang Strip Frame including T-Post, when build-out is over 50.8mm, we will supply build-out loose with holes pre-drilled; also note that for frame not able to pre-drill holes, such as Beaded L Frame, we will supply build-out loose without holes pre-drilled, either.
- For all frames, we will add build-out per the order form. E.g., if the frame type is 76mm L Frame, and build-out is 10mm, we

will use 76mm L Frame added with 10mm build-out instead of changing the frame type to 46.5mm L Frame added with 39.7mm build-out. For bay/corner Post, we will supply build-out in every size pre-attached by default.

- Extension for Z Frame: If you want the timber to be added to bottom of Z frame like the drawing below on the right, please ALWAYS specify in the special note of the order form, "Add extension to light block section". The DEFAULT EXTENSION will be the left drawing.

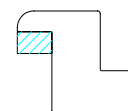

Default

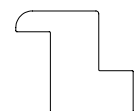

Optional

4. PANEL DETAILS

[BACK TO MENU](#)

SPEC013-2018

STILES

Beaded

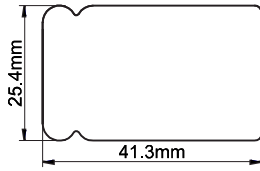

41.3mm Butt Stile

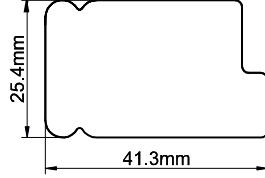

41.3mm Rebate Stile

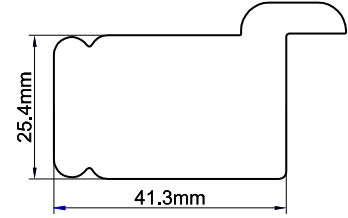

41.3mm D-Mould Stile

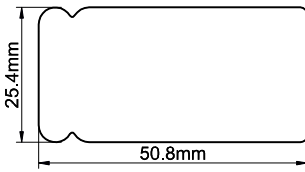

50.8mm Butt Stile

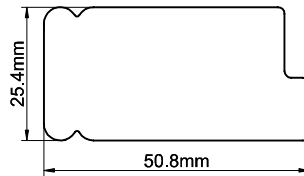

50.8mm Rebate Stile

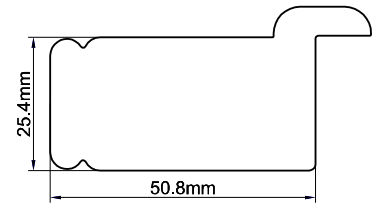

50.8mm D-Mould Stile

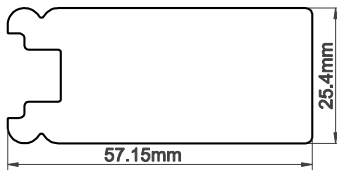

57mm Butt Stile

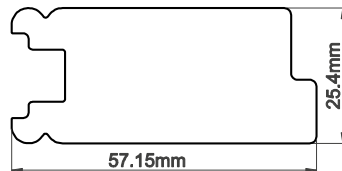

57mm Rebate Stile

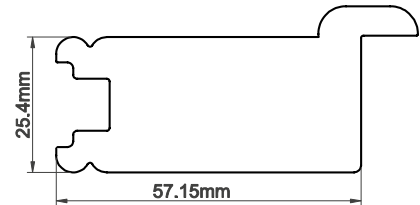

57mm D-Mould Stile

Plain

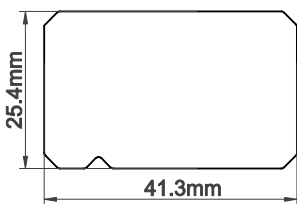

41.3mm Plain Butt Stile

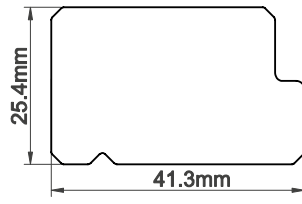

41.3mm Plain Rebate Stile

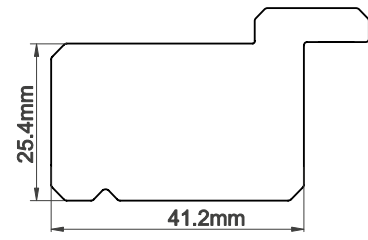

41.3mm Plain D-Mould Stile

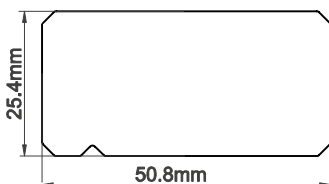

50mm Plain Butt Stile

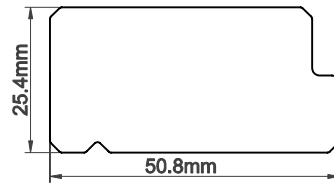

50mm Plain Rebate Stile

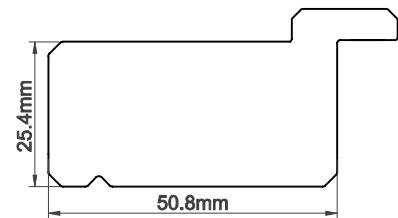

50mm Plain D-Mould Stile

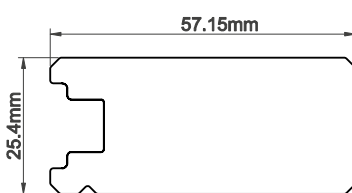

57mm Plain Butt Stile

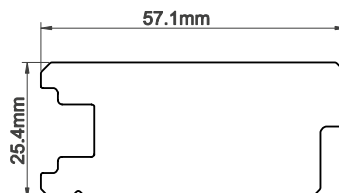

57mm Plain Rebate Stile

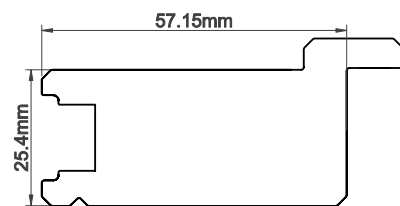

57mm Plain D-Mould Stile

This material belongs to Shuttershop and copying or reproduction in whole or in part is strictly prohibited. We reserve the right to alter specifications without prior notice.

RAILS

The factory will decide the size, unless otherwise specified in the notes section on order form. The top and bottom rail will be the same size if there is no divider rail. If you need different size rails, please specify.

We suggest ordering shutters for the same customer at the same time, so that the rail sizes will match as accurately as possible.

Please note the standard top/bottom rail sizes should be within 69.85mm~165.1mm.

For regular shutters, the increments for the rail size is 3.175mm.



STANDARD MID-RAILS

The Mid-Rail size is 76.2mm high. Different mid-rail sizes cannot be ordered in Antigua.

If the panel height is greater than 1879mm one or more mid-rails are required. If the height from the centre of the mid-rail to the top of the top rail or bottom of the bottom rail is 1879mm or more, then another mid-rail is required. Mid-rail positions should be specified at time of ordering. If the order is placed with no mid-rail then all warranties on the order are automatically waived.

Divider rail:
Standard divider rail is 76.2mm

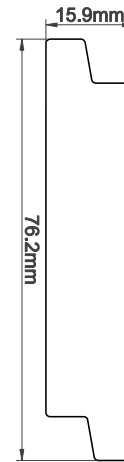

MID-RAIL continued

Specified rail position is taken from the base of the shutter set to the centre point of the rail, except for solid based which is from the bottom to the top of the mid-rail.

The centre rail can deviate by + or - by the amount of millimetres shown below. If the mid-rail is to be exact with no deviation then this must be noted on the order under the notes when placing the order.

Louvre Size	Allowable +/- Deviation
47mm	19mm
63mm	25mm
76mm	31mm
89mm	38mm
114mm	51mm

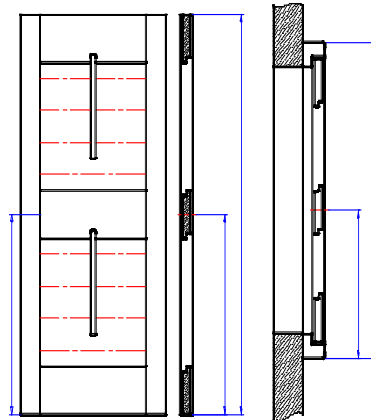

LOUVRES

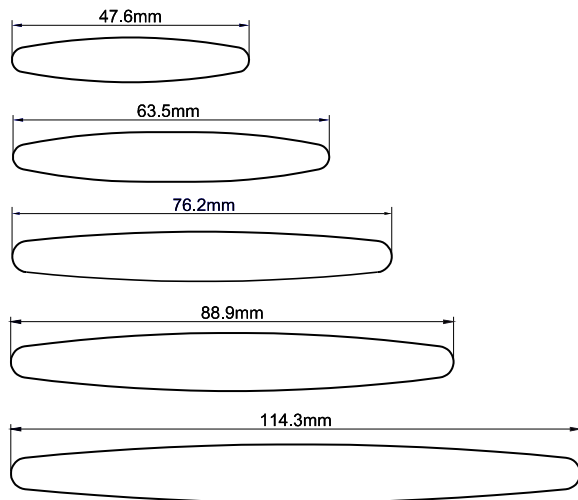

LOUVRE PIN

Louvre pins are used to ensure louvre tension. In addition a tension screw is inserted into one louvre in the panel. This is the same for all louvre sizes. Access holes are drilled in the in the stile for each panel to allow the tightening or loosening of the tension screw, to adjust the louvre tension. Please note therefore additional holes will be visible in the stiles.

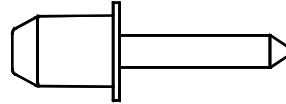

TILT RODS

Standard tilt rod

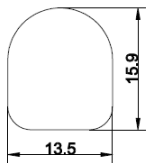

Silent tilt rod

Silent Tilt rod's are integrated into the stile and are not visible. Silent tilt rods are available in 63mm, 76mm, 89mm and 114mm. The 47mm does not have this option.

The Silent Tilt rod will automatically be split into 2 parts when the number of louvres connected to the silent tilt rod exceeds the following limit.

Louvre Size	Max Possible Louvres	Panel Height Range
63mm	24	1289 - 1385mm
76mm	19	1276 - 1372mm
84/89mm	16	1289 - 1385mm
114mm	12	1289 - 1385mm

If the louvre quantity exceeds the above limit, the gear tilt control will be equally split into halves. If the louvre quantity is odd the bottom section will have one more louvre than the top section. If the panel has a divider rail, and the louvre quantity above divider rail or below divider rail exceeds the above limit, split tilt rods are also required.

OFFSET TILT RODS

Offset tilt rods can be ordered. The standard offset is 25mm from the centre of the tilt rod to the end of louvre on hinge side. If a different offset is required please specify the position from the centre of the tilt rod to the end of the louvre on the hinge side in the short notes on the order form.

The centre of the tilt rod will be 25mm from louvre end on hinge side of the panel. For Fixed panels, the offset tilt rods will be positioned on the left side for all panels. For special shaped panels, the offset tilt rods will be on the higher side of the stile.

OFFSET TILT ROD FOR MULTI-FOLD SHUTTERS

Multi-fold panels will be made with the tilt rod offset from the centre to enable panels to be folded flat without tilt rods obstructing one another. The standard offset for the tilt rod is 7mm from the centre, i.e. tilt rod will be 7mm to the left of centre for left panels, and 7mm to the right of centre for right panels. Rebates between panels are made right over left. Bi-Fold panels (LR or LLRR) do not require offset tilt rods.

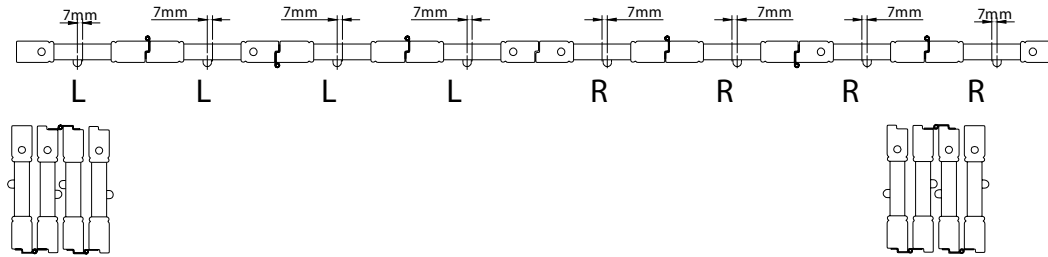

N.B: Multi-fold is only available for tracked shutters in Antigua

5. ROOM DARKENING SHUTTER & SHADE

[BACK TO MENU](#)

SPEC017-2019

ROOM DARKENING BLIND OPTION

DOUBLE INSERT F FRAME

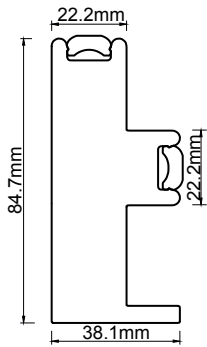

Double Insert F Frame
84mm

*NOTE: When you order Room Darkening blinds and the frame has a T post please note the defaulted specification below:

- If there is no build out with T post, then the Room Darkening blind will be defaulted to one blind sitting behind the T post.
- If there is build out with T post then the Room Darkening blind will be split according to the T post.
- For Double Insert F Frame 84mm, holes for screws will be predrilled. For inside mount, 63.5mm will be supplied and screw hole predrilled under the side insert. For outside mount, 76.2mm screw will be supplied and screw hole predrilled under the front insert. For orders not specified the mount type, no screw holes will be predrilled but 76mm screw will be supplied.

2. Frame mounting:

Outside Mount

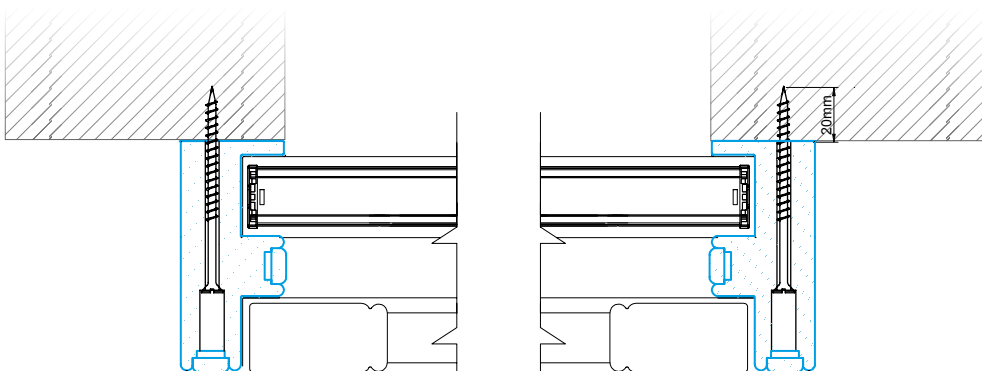
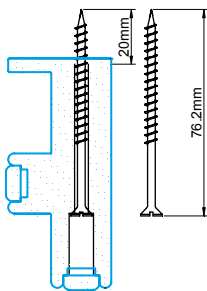

Inside Mount

Will require a minimum depth clearance 30mm. If it is a bay window inside mount, the top and bottom cover strips will be cut flush on both ends, their length = each section frame outer dimension + 50mm

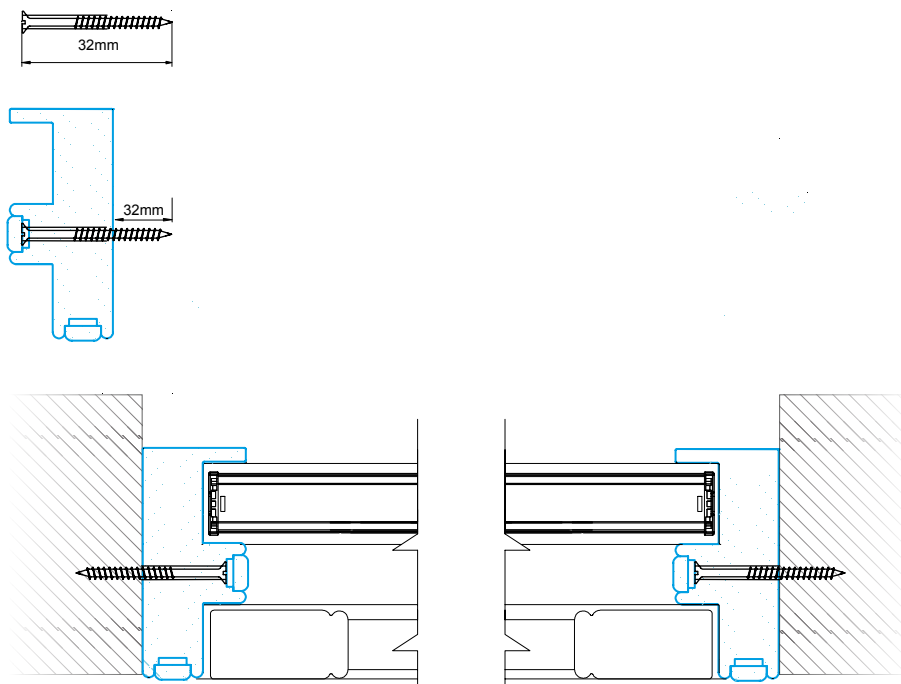

3. Number of frames:

3 sided (top,left & right) and 4 sided.

4. Available shutters:

All rectangular shutters only.

5. Available cellular shade:

25mm corded system cellular shade-room darkening. Pull cord is defaulted to the right side.

* The cord cleat will be on the light block between the shutter and shade.

6. Size limit:

	Min. Size	Max. Size	Max. Area
Width	220mm	2500mm	5.5m ²
Height	250mm	3600mm	5.5m ²

* The above chart does not mean that a shade can be ordered in maximum width and maximum height.

* The shade width and drop must be within the size limitations above and not exceed max area.

If there is a T-Post, Corner/ Bay post, it will be made as below:

1. If the shade behind is for one whole piece, the post and frame will be jointed as picture below:

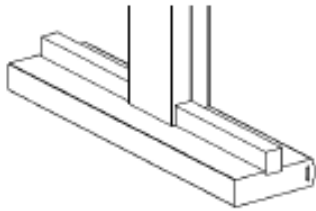

Vantage Hang Strip
76mm

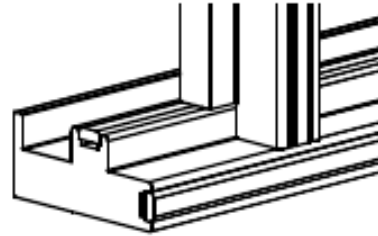

Double Insert F Frame
84mm

2. If the shade behind is divided into several pieces by the T-Post, Corner/ Bay post, then T-post, Corner/ Bay post need to add 29.5mm (hang strip)/38.3mm (Double Insert F frame 84mm) build out at back for the standard frame depth. See picture below:

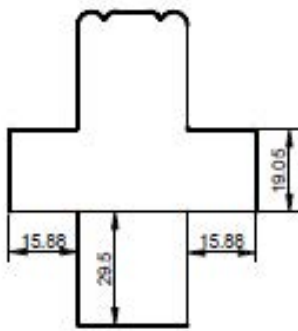

Vantage Hang Strip
76mm

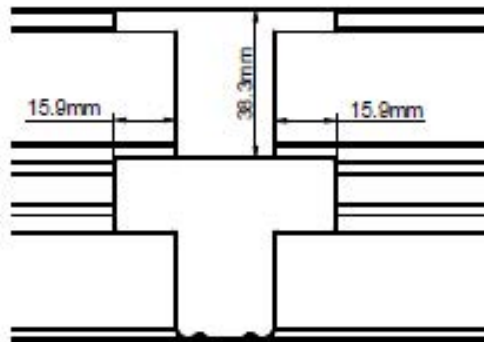

Double Insert F Frame
84mm

For Corner/ bay post, take Double Insert F frame 84mm frame as example:

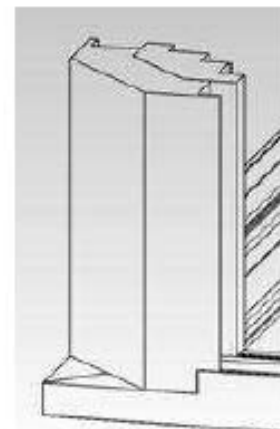
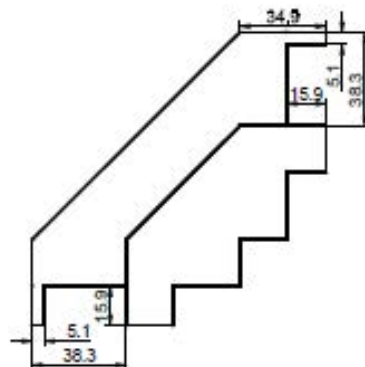
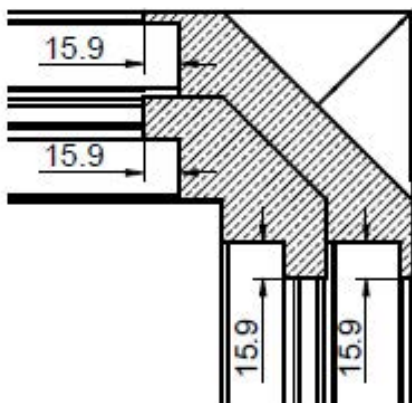

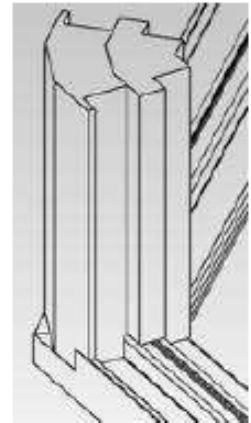
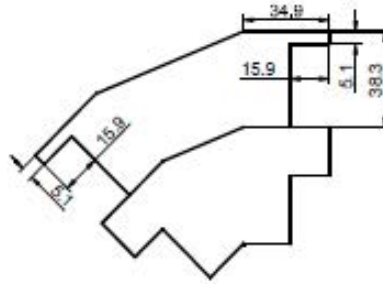
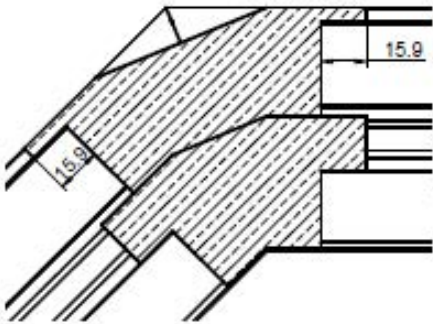

3. For Double Insert Frame 84mm with T-Post , the insert for the Double Insert F Frame 84mm will be cut at the bottom of the posts and there is a 3mm overlap between insert and post. See picture below:

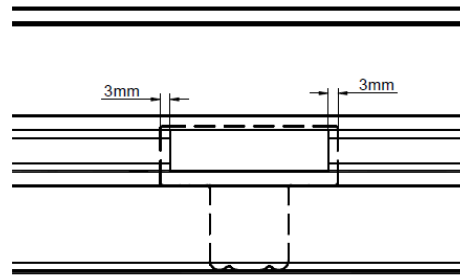
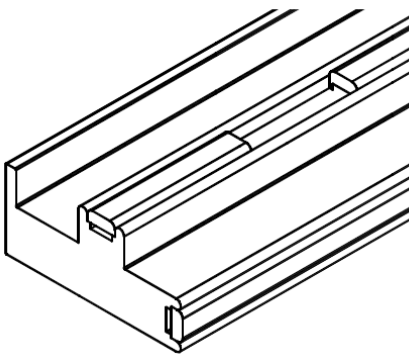



ROOM DARKENING BLIND STACKING HEIGHTS

[BACK TO MENU](#)

Shade Height (mm)	Stacking Height (mm)		Stacking Height (mm)
	Room Darkening	Shade Height (mm)	
254	39	1651	77.8
279.4	39.8	1676.4	78.6
304.8	40.6	1701.8	79.4
330.2	41.4	1727.2	79.8
355.6	42.2	1752.6	80.6
381	43	1778	81.4
406.4	43.8	1803.4	82.2
431.8	44.6	1828.8	83
457.2	45.4	1854.2	83.4
482.6	45.8	1879.6	84.2
508	46.6	1905	85
533.4	47.4	1930.4	85.8
558.8	48.2	1955.8	86.2
584.2	49	1981.2	87
609.6	49	2006.6	87.8
635	49.4	2032	88.6
660.4	50.2	2057.4	89.4
685.8	51	2082.8	89.8
711.2	51.8	2108.2	90.6
736.6	52.6	2133.6	91.4
762	53.4	2159	92.2
787.4	54.2	2184.4	93
812.8	54.6	2209.8	93.4
838.2	55.4	2235.2	94.2
863.6	56.2	2260.6	95
889	57	2286	95.8
914.4	57	2311.4	96.6
939.8	57.8	2336.8	97
965.2	58.6	2362.2	97.8
990.6	59	2387.6	98.6
1016	59.8	2413	99.4
1041.4	60.6	2438.4	100.2
1066.8	61.4	2463.8	100.6
1092.2	62.2	2489.2	101.4
1117.6	62.6	2514.6	102.2
1143	63.4	2540	103
1168.4	64.2	2565.4	103.4
1193.8	65	2590.8	104.2
1219.2	65.8	2616.2	105
1244.6	66.2	2641.6	105.8
1270	67	2667	106.6
1295.4	67.8	2692.4	107
1320.8	68.6	2717.8	107.8
1346.2	69	2743.2	108.6
1371.6	69.8	2768.6	109.4
1397	70.6	2794	110.2
1422.4	71.4	2819.4	110.6
1447.8	72.2	2844.8	111.4
1473.2	72.6	2870.2	112.2
1498.6	73.4	2895.6	113
1524	74.2	2921	113.8
1549.4	75	2946.4	114.2
1574.8	75.8	2971.8	115
1600.2	76.2	2997.2	115.8
1625.6	77	3022.6	116.6

Stacking height schedule: Please note stacking height is just for your information not to the exact height.

**ROOM DARKENING BLIND
25MM COLOURS**

Brie C4510

Sand C4508
<i>No colour image not currently available</i>
Desert C4504

Primrose C4506
<i>No colour image not currently available</i>
Tamarind C4507
<i>No colour image not currently available</i>
Black Ink C4201

Dusk C4105
<i>No colour image not currently available</i>
Steel Grey C4101
<i>No colour image not currently available</i>
Infinity C4108
<i>No colour image not currently available</i>
Champagne C4111
<i>No colour image not currently available</i>

Mineral C4108
<i>No colour image not currently available</i>
Pebble C4509
<i>No colour image not currently available</i>
Indigo C4704
<i>No colour image not currently available</i>
Fog Green C4601

Slate C4104
<i>No colour image not currently available</i>
Terra C4102

Topaz C4705
<i>No colour image not currently available</i>
Glacier White C4001

Ecru C4412
<i>No colour image not currently available</i>

6. HARDWARE

HARDWARE

Self-Mortise Hinge:

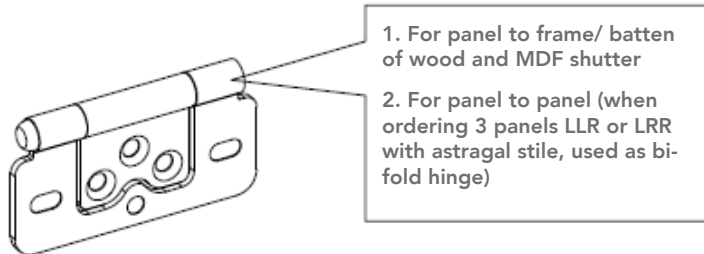
We will pre-mount the inner piece of hinge on panel when order Overall Panel size and OD of frame, the outer piece and the hinge pin will be included in the hardware box: for OD of frame size, will be attached to the outer piece and hinged to the frame with one screw through the oblong hole.



Offset Hinge:

Used for rebated stiles. All hinges will be pre-mounted on panels.



1. For panel to frame/ batten of wood and MDF shutter
2. For panel to panel (when ordering 3 panels LLR or LRR with astragal stile, used as bi-fold hinge)

L Hinge:

Used for hang strip inside mount.

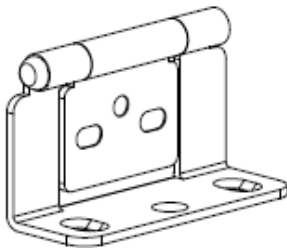

Hinge Spacer:

To make installing shutters an easier experience, we have included hinge spacers for your convenience. It is very common to find windows that are built square, and depending on the evenness of the mounting surface and how the shutters are installed, the outcome of the installation might be different. The hinge spacer is an easy and reliable tool to help installers overcome such variations during the installation process.

Hinge Colours
Antique Brass, Bright Brass, Black, Nickel Plated, Stainless Steel (Surcharge), Brushed Nickel Plated (Surcharge), White, Pearl, Bisque, Pure White

Please Note:
End of hinge to top/bottom of panel is 50.8mm.

For the ANTIGUA program

Panel height	No. of hinges
<=1219mm	2
1219mm~1981mm	3
1981mm~2438mm	4
2438mm~3048mm	5
>3048mm	6

MAGNETS

Round magnets are pre-mounted on the panels and the catch is pre-mounted on the frame when the order is 'OD' type. An 'L' shaped magnet catch is included in the hardware box when ordering 'OP' type.



Catchplate



Magnet

HANDLE OPTIONS

Handle A and B are available to order in Nickel Plated only. Please specify the handle you require along with the quantity on the notes section of your order card, they will not be pre installed but supplied loose in the hardware box. (Surcharge will apply).



Handle A



Handle B

HOFFMAN KEYS

These are supplied and are used to join frame corners together.



L SHAPE MAGNET CATCH

When ordering a 3 sided frame with the gap more than 2.5mm ordering OP OR, an L shape magnet catch will be supplied.



PANEL FEET

For MDF and MDF+, panel feet will be included in hardware box when ordering OP panels, and mounted on bottom of panels when ordering panels with frame (OD of frame).

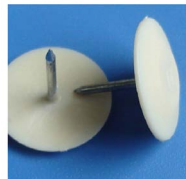

SIDE MAGNETS

This option is available in the order card and when selected we will add a magnet situated to the side of stile (1). It can be selected where a Left and Right panel meet where there is no lightblock or bottom frame to secure the panels. The magnets will act to keep the panels together.

Side magnets are available for butt, rebate and D-Mould stile, not available for the Java product.



(1) Magnet shown in side of stile



(2) Magnet keeping panels together

The side magnet can be selected where you have:

- a) Door shutters that require bottom clearance.
- b) Tier on Tier shutters without horizontal T post. The side magnet will be installed on the top of the bottom tier and the bottom of the top tier (3).
- c) Café style shutters with upside down goal post frame (4).
- d) Window that do not have a light block or bottom frame (5).

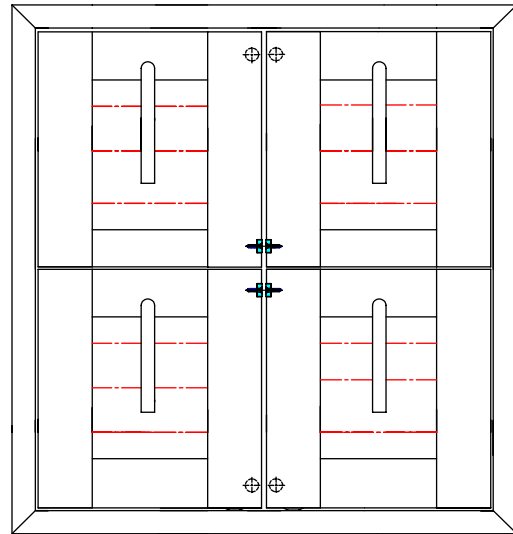

(3) Double Hung shutter without horizontal T post

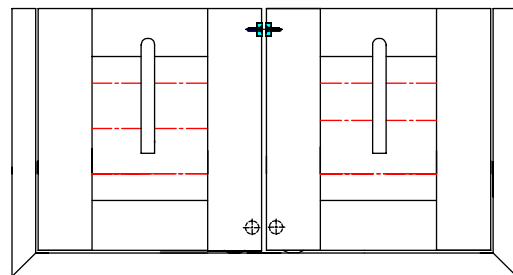

(4) Café Shutter

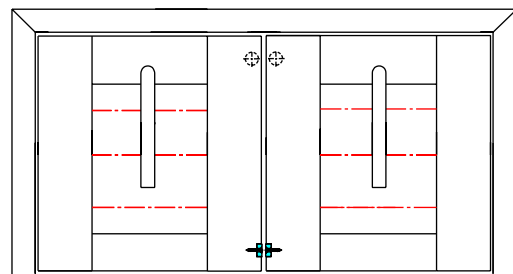

(5) No frame or light block on either top or bottom

BOLTS & RING PULL



1. Barrel Bolt

Can be used for hinged shutter and Bi-fold track shutter to fit panels. Based on the size of the bolt, 50.8mm stile should be used for this product.



2. Ring Pull

Can be used for hinged shutter and track shutter. Based on the size of the ring pull, 50.8mm stile should be used for this product. For the location of the ring pull, refer to the bolt location.

RING PULL & BARREL BOLT

LL

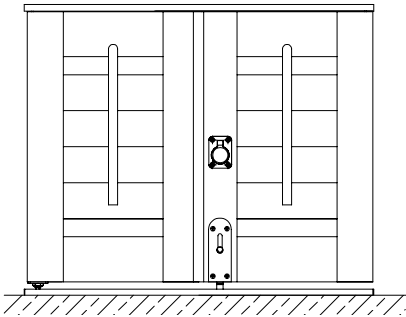

RR

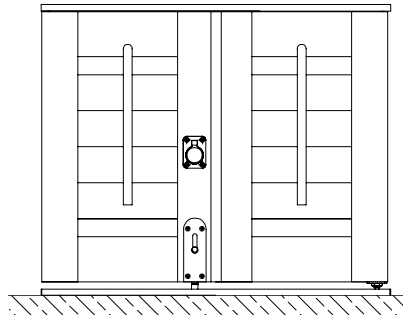

LLL

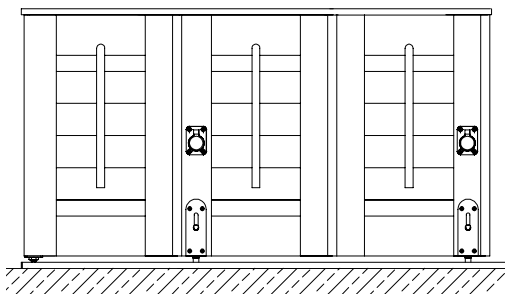

RRR

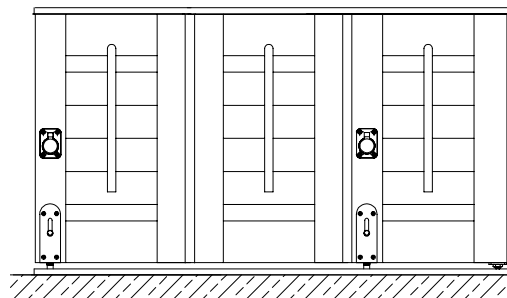

LLRR

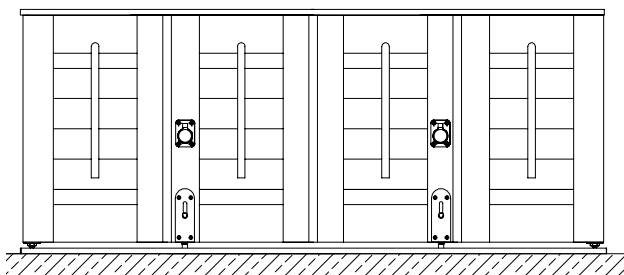

LLL

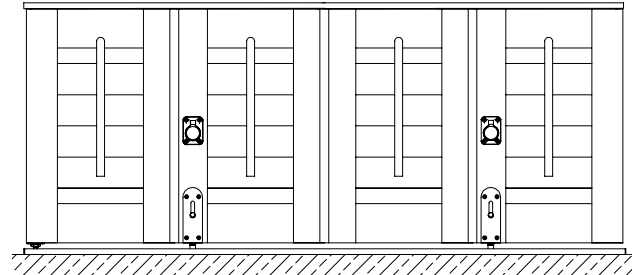

RING PULL & BARREL BOLT Cont.

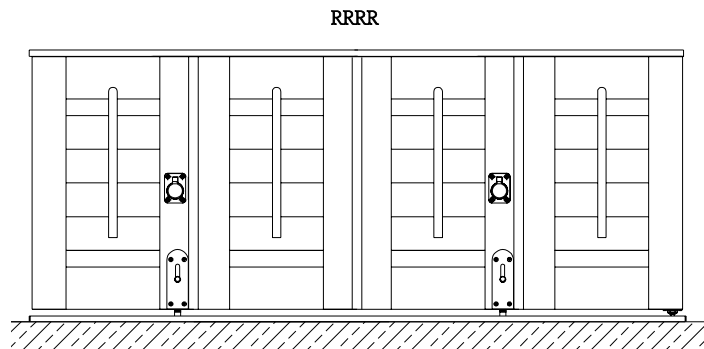

The bolt location for both track system shutters and regular shutters would be the same. The general principle is that the bolt position will avoid the stile which has the spring-loaded guide at the bottom (same stile as the wheel carrier).

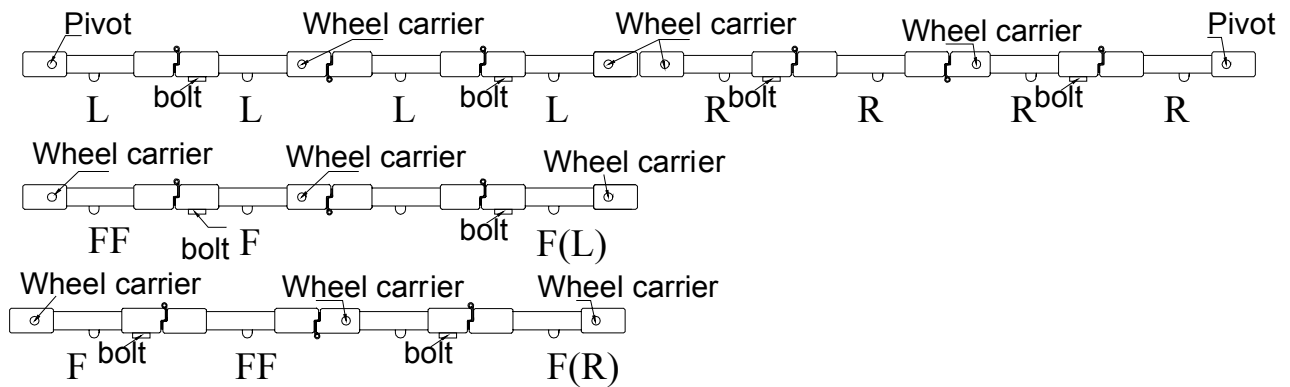

Ring pull: for easy opening and closing (Not available for 41mm Stile)

Ring Pull and Barrel Bolt: Customer needs to specify ring pull location on the order. Ring pull location principle for Floating Panels: (same as the location of 90° Bifold Track)

1. When floating panel config is in pairs, it will be split into halves, the left will be for LL and the right will be for RR. So the ring pull location for FF/FF, FF/FF/FF/FF will be same as that of panel config as LL/RR, LL/LL/RR/RR.
2. When floating panel config is FF, the ring pull location will be same as that of panel config LL.
3. When floating panel config is singular, it will be split into 3 sections, the left and mid sections are for LL and the right section is for RR. So the ring pull location for FF/FF/FF, FF/FF/FF/FF/FF will be same as that of LL/LL/RR, LL/LL/LL/RR/RR.

Please note the ring pull colour will match with the hinge colour.

Please see the matching chart below:

Hinge	Pure White	White	Bisque	Pearl	Black	Nickel	Brushed Nickel	Antique Brass	Bright Brass	Stainless Steel
Ring Pull	White	White	Bisque	Pearl	Black	Brushed	Brushed Nickel	Antique Brass	Bright Brass	Brushed Nickel

Position: For different panel configuration, please refer to the location of bolt to show on which stile the pull will be fixed.

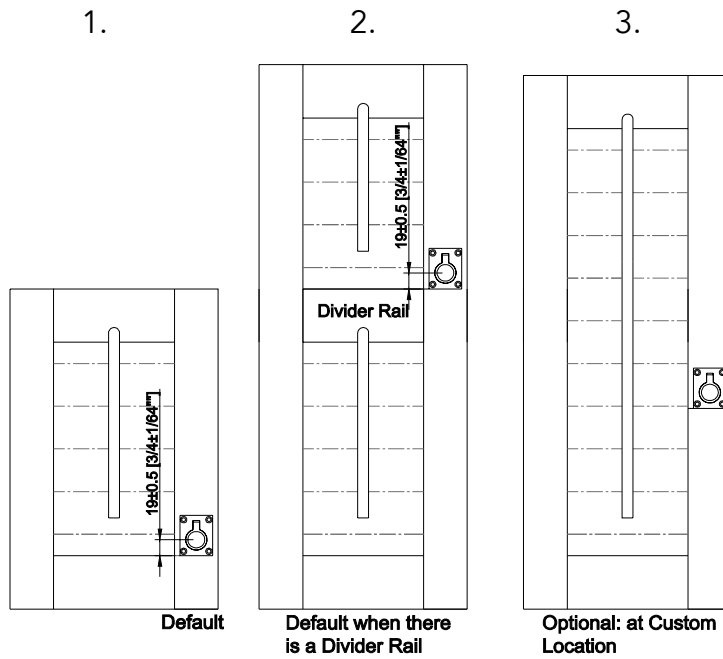

Position:

1. Above Bottom Rail (Default)
2. Above 1st Divider Rail (Default when there are Divider Rails)
3. Custom Location

If both bolt & ring pull are specified, the distance between them is 2 3/4" (70mm), and the ring pull location is 6 3/4" (170mm) from the bottom of panel.

When there is no mid rail, ring pull will be just on the top of Bolt (2 3/4" /70mm above bolt) as default location; if there are mid rails, bottom of ring pull lines up with top of the 1st mid rail as default location.

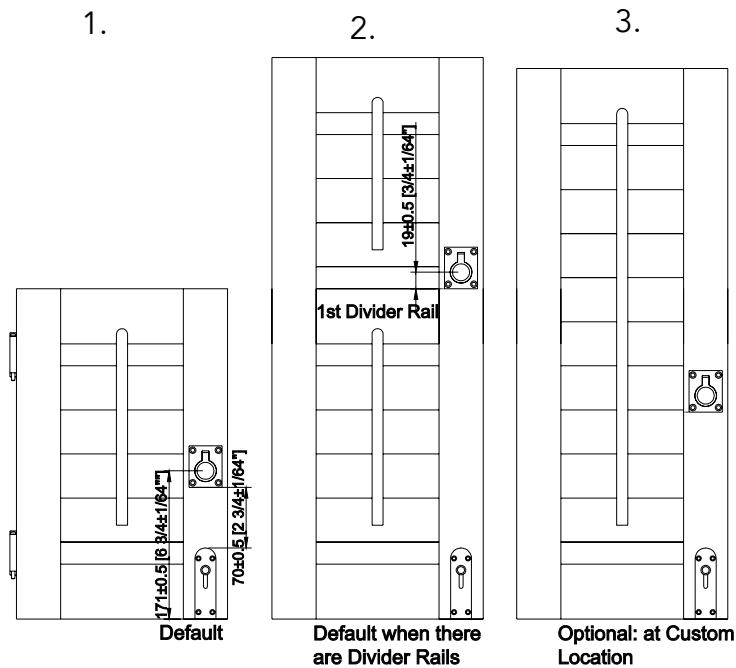

Position:

1. 2 3/4" (70mm) Above bolt (Default when both Ring Pull and bolt are specified)
2. Above 1st Divider Rail (Default when there are Divider Rails)
3. Custom Location

Measurements:

Window size: Measure from the bottom of the window to the centre of the ring pull

Max frame-to-frame: Measure from the bottom of the frame to the centre of the ring pull

PANEL CONFIGURATIONS

If you order shutters in OVERALL PANEL SIZE & OD OF FRAME, panel configuration is required. Please specify if the stile type required is Rebate or D-Mould. Butt is default for single panel.

1 panel: L/R

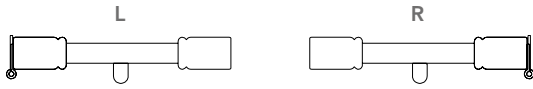

2 panels: LL/RR/LR

A) Rebate stile

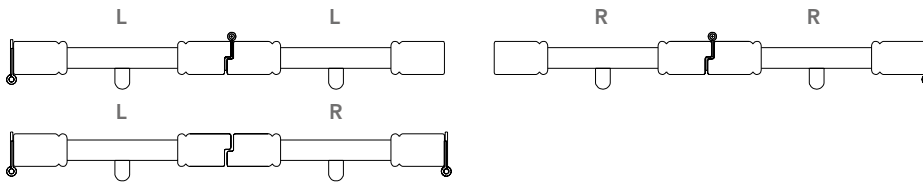

B) D-Mould stile

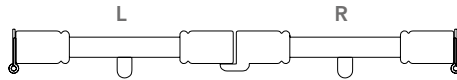

3 panels: LLR/LRR

A) Rebate stile

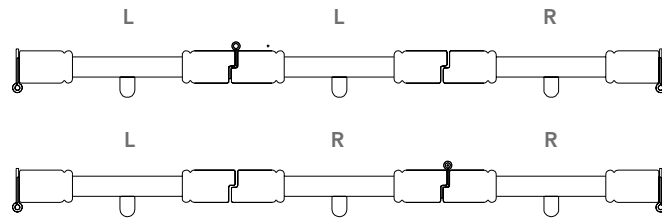

B) D-Mould stile

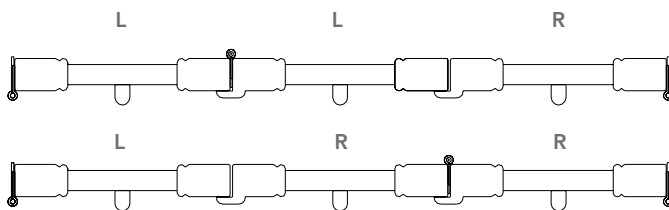

4 panels: LLRR

A) Rebate stile

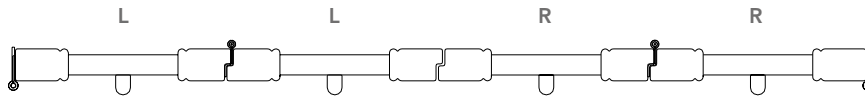

B) D-Mould stile

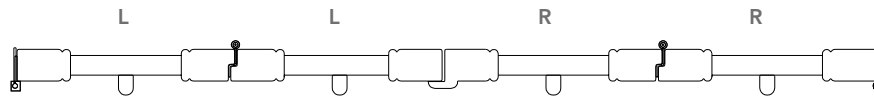

Offset tilt rod for multi-fold shutters (tracked only)

For multi-fold panels, we will place the tilt rod offset from the centre. By doing so, panels can be folded from the centre. By doing so, panels can be folded flat without tilt rods obstructing each other.

The standard offset for the tilt rod is 7mm from the centre, i.e. tilt rod will be 7mm to the left from the centre for the left panels, and 7mm to the right from the centre for the right panels. Besides, the Rebate is made with right panels over left ones for both the panels folded to left and to right.

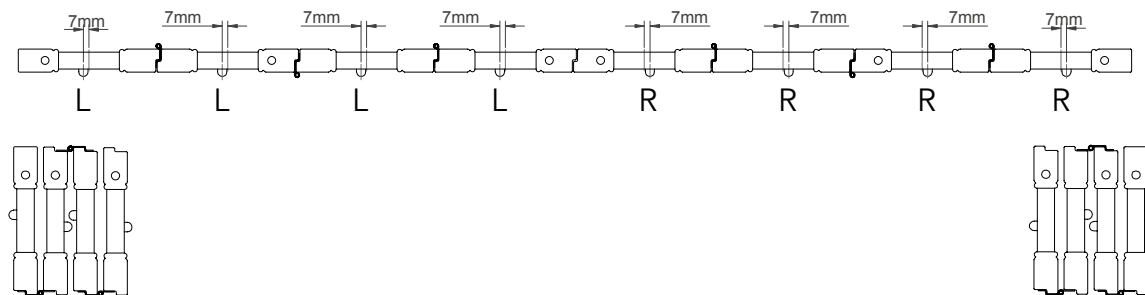

* For 2 panels (LL/RR) and 4 panels configuration (LLRR), there is no need to offset the tilt rod.

7. SIZING AND MEASURING

PANEL SIZE LIMITATIONS

Panel structure

The shutter panel is made up of several parts. To help you understand the panel construction please see photograph.

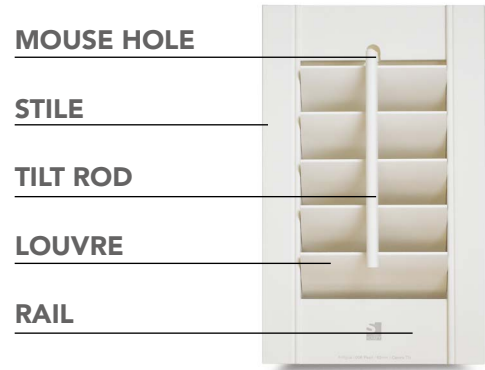

Louvre Size	Width			Height			
	Minimum	Maximum		Maximum number of untracked Multi-fold panels	Minimum	Maximum without mid rail	Maximum with mid rail
		Single hung	Bi-fold hinged shutter/ Multi-fold with Top and Bottom track				
47mm	152mm	600mm	600mm	2	250mm	1879mm	3000mm
63mm	152mm	750mm	600mm	2	250mm	1879mm	3000mm
76mm	152mm	750mm	600mm	2	250mm	1879mm	3000mm
89mm	152mm	750mm	600mm	2	250mm	1879mm	3000mm
114mm	152mm	750mm	600mm	2	250mm	1879mm	3000mm

NB: Where the panel size limits above are exceeded, warranty on the order line is waived automatically.

NB: When a single hung panel width is less than 228.6mm and used with the following frames: Deco, L, Z and Hang Strip, the stile opposite to the hinge will be rebated.

If panel height is over 1879mm, a Mid Rail is required and if the panel has a Mid Rail but the height from the centre of the Mid Rail to the top of the top rail or to the bottom of bottom rail is still over 1879mm, another Mid Rail will be required.

If you do not specify the Mid Rail location, the order will be held to confirm if a Mid Rail is required. However, if you specify no Mid Rail, you will waive your warranty and manufacture will proceed as per your instructions.

Shutter used for door or without bottom support:

In situations where shutters are used for door applications, or no bottom support.

Please note:

- (1) The factory will add extra hinges to support the panels.
- (2) Bigger and Stronger Top and Bottom rails will be added to reduce the probability of the panels sagging and increase shutter intensity.
- (3) If customers fail to notify that the shutter will be used in door applications, the customers will be responsible for the cost of the any re-order that is submitted.

Please see the following chart for details.

Panel Configuration	
L,R,LR	LL, RR, LLRR
Manufactured with warranty waived	Only available with a tracked installation. Not covered by warranty if not ordered as a track system.

PANEL WEIGHT

Panel Weight		
Material	Louver size	Weight (kg)/m ²
Antigua	47mm	10.23
	63.5 mm	9.90
	76.2 mm	9.95
	88.9 mm	10.01
	114.3 mm	8.93

* Average Weight

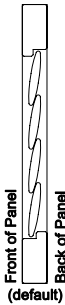
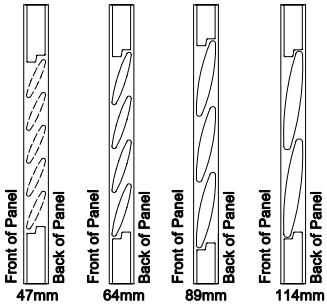
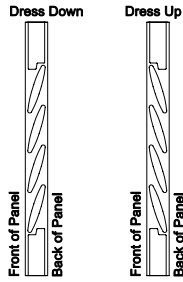
FIXED LOUVRE OPTIONS		
	Fixed Closed Position	Fixed Open Position
<p>Available in two positions: closed or open at angle. Available in 5 louvre sizes, 47mm, 63mm, 76mm, 89mm, 114mm</p>	 <p>Front of Panel Back of Panel (default)</p>	 <p>Front of Panel Back of Panel 47mm</p> <p>Front of Panel Back of Panel 64mm</p> <p>Front of Panel Back of Panel 89mm</p> <p>Front of Panel Back of Panel 114mm</p>
<p>The standard default orientation for Fixed louvres is Closed 'Dress Down' with the bottom edge of louvres to the front of the panel. 'Dress Up' option is also available if specified on the order form.</p> <p>NB. Note that normal orientation for <i>adjustable louvres</i> when closed is in the 'Dress Up' state.</p>	 <p>Dress Down</p> <p>Dress Up</p> <p>Front of Panel Back of Panel</p> <p>Front of Panel Back of Panel</p>	

ORDER SIZE DEFINITION

Overall Panel size (OP):

The size given is the overall panel size. The width does not include the hinge space from panel to batten on the left & right side, but does include the gap between panels, the standard gap is 2mm between panels and we will calculate the single panel width based on this measurement (see diagram below). The height given must be net panel height. We will pre-mount the hinges and the magnets and include panel feet and L shape magnet catches in a hardware box.

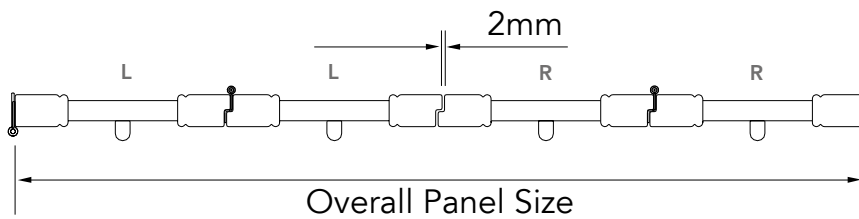

OD of frame:

Size given is "Outside Dimension" of the shutter; we will pre-mount the hinges and the magnets, and will include all the necessary hardware in a hardware box. The stiles can be Rebate and D-Mould stile, please specify on the order form.



Camber Deco Frame 50mm: Can only be ordered as outside mount, the size given must be OD of frame size.



"Z" frame: Can only be ordered as inside mount, the size given must be OD of frame size. (Backside of Z frame, refer the drawings).

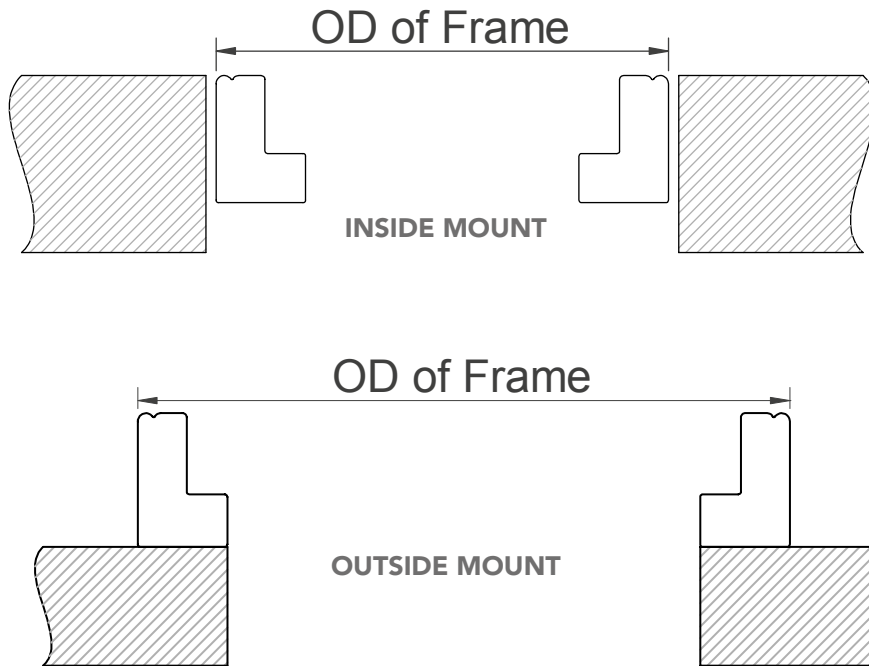

"L" frame: Can be ordered as inside mount and outside mount, size given must be OD of frame size.

TOLERANCES

Width: The width of the panel can be plus or minus 1.6mm from the order width.

Height: The height of the panels can be plus or minus 1.6mm from the order height.

Mid Rail location: Mid Rail location may be off by half a louvre space. Measure from bottom of bottom frame to centre of Mid Rail if order OD of frame, and from bottom of panel to centre of Mid Rail if order net panel size or overall panel size.

For 47mm louvre can be off by +/-19mm.

For 63mm louvre can be off by +/-25mm.

For 76mm louvre can be off by +/-31mm

For 89mm louvre can be off by +/-38mm.

For 114mm louvre can be off by +/-51mm.

MOUNTING TYPE

Café style shutter: Please specify on the order form if the shutter is a café style. We will finish the top of the panels and one end of the battens.

If a café shutter is required with a 3 sided frame, it should be 3 sides inverted.

Tier on Tier: The standard gap between the top tier and bottom tier is 2.5mm.

Full height: Regular shutters running the full height of a window.