

FIJI TECHNICAL SPECIFICATIONS

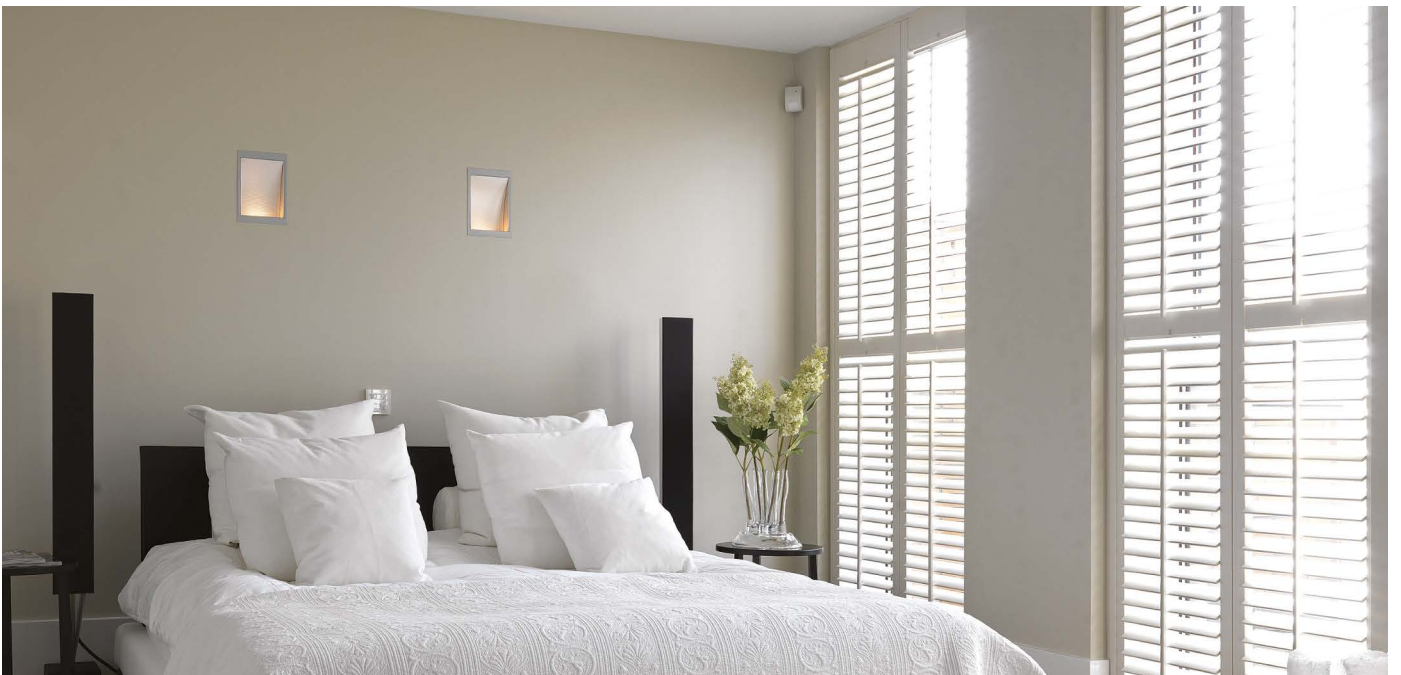

2019 Version 1.6

The**ShutterShop**

FIJI SPECIFICATIONS CONTENTS

To go to required section click coloured headings below

Section 1			
Introduction	3	Battens	15
Specifications	4	Section 4	
Colours	5	Panel details	16
		Stile	
Section 2		Rails	17
Installation Styles	7	Solid Panels	
Full Height		Louvres	18
Cafe Style		Flat Louvres	
Tier on Tier		Louvre pin	
Tracked Shutters		Tilt Rods	
Unsupported Shutters		Standard tilt rod	
Solid Panels	8	Silent tilt rod	
Special Shapes		Offset tilt rod	19
Roof Windows		Offset tilt rod for Multi-fold Shutters	
		Roof Window Specifications	
Section 3		Section 5	
Framing elements	9	Room Darkening	20
Frame styles	10		
Beaded		Section 6	
Bullnose L		Hardware	25
Insert L		Bolts & Ring Pulls	27
Plain L		Panel Configurations	31
Tiara Z			
Crown Z		Section 7	
Beaded Z		Sizing & Measuring	36
Bullnose Z		Order Size Definition	
Ridge Deco		Overall Panel size (OP)	
Camber Deco		Overall Dimension of frame (OD)	
Insert Hang Strip	13	Tolerances	37
Cover Strip		Mounting Type	
T Posts			
L/Z			
Deco			
Insert T			
Corner Posts			
L/Z			
Deco			
Bay Posts	15		
L/Z			
Deco			

1. FIJI INTRODUCTION

The painted Fiji range is manufactured from premium hardwoods. The Fiji stain range is manufactured from Paulownia. These woods are beautiful and stable timbers manufactured using the same high quality standards as all of our shutters

Colour palette:

There are a total of 50 contemporary colours available including a custom colour option.

Material Features and Benefits of the stained range of Fiji shutters manufactured in Paulownia:

Lightweight:

Paulownia has an average weight of 6.8 to 7.6kg/sqm depending on the type of shutter chosen. This makes it extremely lightweight and ideal for large window expanses or windows situated within roof spaces. It has one of the highest strength to weight ratios.

Aesthetics:

Paulownia has a beautiful light to honey blonde colour and is very receptive to stains where the natural grain shows through. Paulownia is dimensionally stable and a consistently knot free hardwood.

Due to its low thermal conductivity Paulownia is excellent at keeping homes cool in the summer and warm in winter.

Sustainability:

The Paulownia tree is one of the world's fastest growing tree species and sawn timber can be harvested in 10 years and after harvesting a new tree can grow from the original stump using the old and well established root system. This procedure can be repeated several times, saving post harvest clearing and land erosion. It also has massive leaves which remove huge amounts of carbon dioxide from the air replenishing this with oxygen and the leaves that drop each winter release nitrogen and increase soil fertility.

Frames and Panels:

Large range of frames available.

Stiles:

Please note the stiles are manufactured in a flat or beaded stile. The engineered stiles are reinforced by using multiple layers of wood bonded together ensuring that the panel does not twist or warp.

Louvres:

Fiji is available in 47mm, 63mm, 76mm, 89mm, 114mm elliptical louvres.

Special Shapes:

Linear and curved special shapes are available.

Colour palette:

There are a total of 23 contemporary paint colours and 27 stain colours available including a custom colour option.

FIJI SPECIFICATIONS

PANEL SIZE LIMITATIONS

Louvre Size	Width				Height		
	Minimum	Maximum	Single hung	Bi-fold hinged shutter/ Multi-fold with Top and Bottom track	Multi-fold hinged shutters & multi-fold with Top track only	Minimum	Maximum
47mm	152mm	750mm	660mm	550mm (No. of panels ≤ 4)	250mm	3000mm	H>1981mm
63mm	152mm	890mm			250mm	3000mm	H>1981mm
76mm	152mm	890mm			250mm	3000mm	H>1981mm
89mm	152mm	1047mm			250mm	3000mm	H>1981mm
114mm	152mm	1047mm			250mm	3000mm	H>1981mm

SPECIFICATIONS

Material	Paint Hardwood, Stain Paulownia
Panel Weight per sq. metre	6.8-7.6kg
Paint Colours	23
Stain Colours	27
Custom Colours available	✓
Louvre sizes	47mm 63mm 76mm 89mm 114mm
Max single panel width	750mm : 47mm 890mm : 63mm 890mm : 76mm 1047mm : 89mm 1047mm : 114mm
Max multi panels width	550mm : ALL
Max number of panels hinged together	4 (1 If Doorway)
Max and min panel heights. (For panel height over 2500mm, it is suggested using 50.8mm or 57mm stile to aid structural integrity).	3000mm 250mm
Solid Panels available	✓ (limited)
Special shapes	✓
Custom Bay Post angles	✓
Stile Type	Plain or Beaded
Fixed Louvres	✓

FIJI COLOURS

COLOUR OPTIONS

FIJI PAINT OPTIONS (23 COLOURS)				
Colour ID	Colour Name		Default Hinge Colour	Optional Hinge Colour
001	Pure White		Pure White	1. Pure White 2. White 3. Pearl 4. Bisque 5. Antique-Brass 6. Bright-Bass 7. Stainless 8. Black 9. Nickle-Plated 10. Brushed Nickle-Plated
002	Extra White		White	
003	Silk White			
004	Bright White			
006	Pearl		Pearl	
007	Ivory Lace		Bisque	
009	Creamy			
011	Cameo			
012	Crisp Linen			
013	Bisque			
014	Alabaster			
016	Butter			
019	String		Nickel Plated	
030	Moondust			
032	Sea Mist			
048	Chai			
049	Stone Grey			
051	Brown Grey			
053	Clay			
066	Winchester White 2010		Pearl	
072	Mattingley 267			
080	Taupe Grey			
836*	Classic Black			

* Custom colour surcharge will be applied to this order.

Due to the nature of material manufacturing, colours may vary slightly between dye lots. Please order shutters for the same home at the same time. Slight variations may also occur between the finished products and the colour swatches you use.

FIJI STAIN COLOURS (27 COLOURS)				
Colour Code	Shutter Colour		Hinge Colour	
			Default Colour	Optional
108	Rustic Grey		Nickel Plated	1. White 2. Pearl 3. Bisque 4. Antique-Brass 5. Bright-Bass 6. Stainless 7. Black 8. Nickle-Plated 9. Brushed Nickle-Plated
109	Weathered Teak			
110	Limed White		White	
111	Pebble		Antique Brass	
114	Taupe			
202	Golden Oak			
204	Oak Mantel			
205	Goldenrod			
211	Cherry			
212	Dark Teak			
215	Cordovan			
219	Mahogany			
220	New Ebony			
221	Black Walnut			
227	Red Oak			
229	Rich Walnut			
230	Old Teak			
232	Red Mahogany			
233	Dark Mahogany			
237	Wenge			
242	Auburn			
246*	Matte Black		Black	
252	Toffee		Antique Brass	
254	Driftwood		Nickel Plated	
255	Silver Grey		White	
256	Mist		Antique Brass	
862	French Oak			

* Custom colour surcharge will be applied to this order.

Due to the nature of material manufacturing, colours may vary slightly between dye lots. Please order shutters for the same home at the same time. Slight variations may also occur between the finished products and the colour swatches you use.

2. INSTALLATION STYLES



FULL HEIGHT

Shutter covering the full height of aperture.

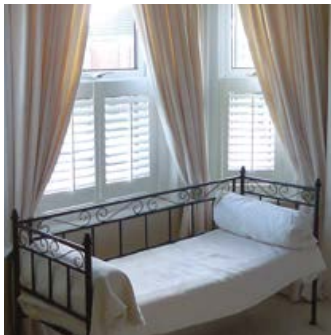

CAFE STYLE

Shutter covering only the lower portion of aperture providing privacy and light control but leaving the top portion un-shuttered to maximise light, where privacy is not required.



ROOF SHUTTERS

Shutters to be installed in an angled or horizontal window. Please refer to specifications on page 19.



TIER ON TIER

Shutter is split into two halves so the top and bottom panels can be independently operated / opened fully. The standard gap between top tier and bottom tier is 2.5mm. For multi-fold tier on tier shutters only 3 or less multi-fold panels are within warranty.



TRACKED SHUTTERS

Bi-Fold

Shutters suspended from a top track hinged together in a bi-fold configuration to allow them to be folded back to the end of the track at 90° or 180°. Suitable for use with patio doors, wardrobes or as a room divider. May be specified and fitted with or without side frames.

By-Pass

Shutters suspended from a top track. Panels slide behind or in front of one another to open or close. Suitable for use with patio doors, room dividers and wardrobes. May be specified and fitted with or without side frames.

* Refer to the separate track specifications for further details.



SHUTTERS USED AS DOORS

In situations where shutters will be used for a door application which does not have support underneath the panels, the customer must inform when placing the order.

Panel Configuration

L, R, LR	LL, RR, LLRR
Manufactured with warranty waived	Only available with a tracked installation. Not covered by warranty.

Please note:

1. The factory will add extra hinges to support the panels
2. The factory will add a larger and stronger top and bottom rail. This will reduce the risk of panels sagging.

*We only offer triple-fold panel configuration (e.g. LLL/RRR) Tier on Tier Shutter.
If a four-fold panel configuration (e.g. LLLL/RRRR) tier on tier is requested then the warranty will be waived automatically.



SOLID PANELS

Solid panels are available in the following materials.

Material	Solid panels
Fiji	Solid Raised, Solid Based



SPECIAL SHAPES

Special shapes including, Fan top (radiating semi-circle), Arched, Angled, Horizontal or Radiating Circles, Octagon, Hexagon and Oval are available.

CAD drawings are produced for all shapes for approval prior to production. Please double check every dimension on the CAD to ensure accuracy. They are not provided for rectangular shutters.

Templates or precise technical drawings are always required for:

- inside mount special shapes
- imperfect arches
- when the shutter covers window mouldings
- oval shapes
- frames requiring cut-outs

They are not required for rectangular shutters.

Some popular shapes - others available.

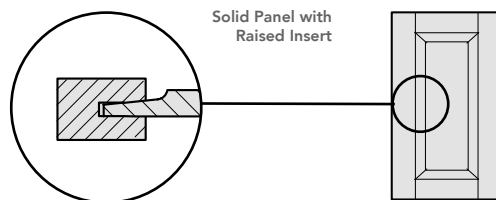
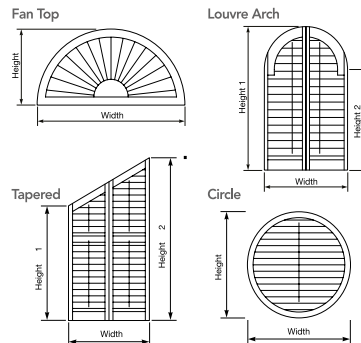
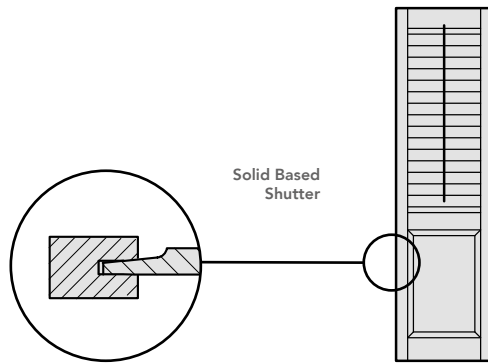

NB. The insert frame comes with a removable insert. However, when used on a curved special shape it is not possible to make the curved frame with the removable insert so a fixed version of the frame is used instead. Where the special shape involves straight sections and curved frame sections (e.g. and Arched shutter) it is possible to specify a removable insert on the straight sections and combine these with the fixed inserts on the curved sections. However, the junction where the insert meets the fixed frame may be unattractive as a result so this option is not recommended. If you wish to specify inserts on the straight section, please indicate this in the short notes on the order form.

FRAMING STYLES

BEADED

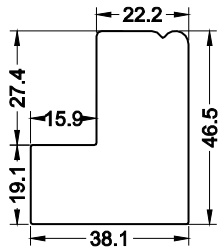

46mm

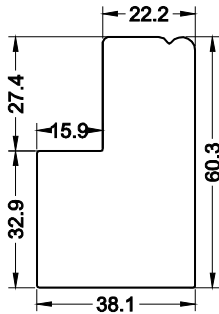

60mm

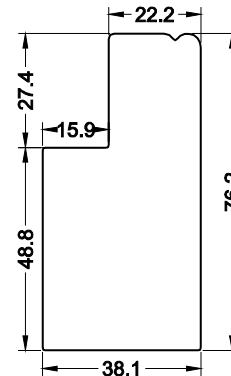

76mm

INSERT L

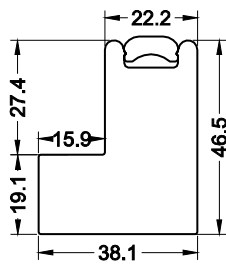

46mm

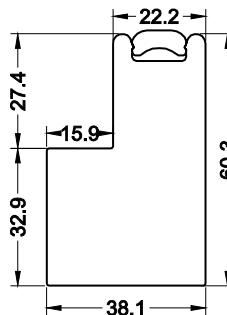

60mm

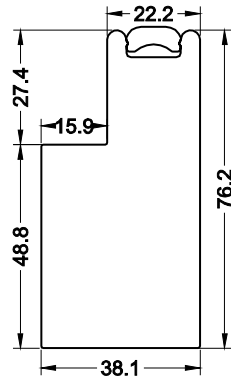

76mm

PLAIN L FRAME

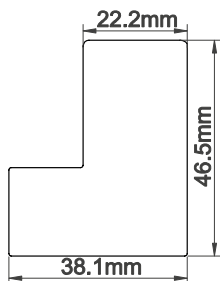

46mm

PLAIN DEEP L W/INSERT

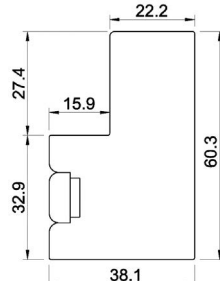

60mm

FRAMING STYLES

TIARA Z FRAME

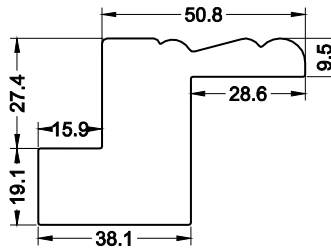

50mm

TIARA Z SILL PLATE

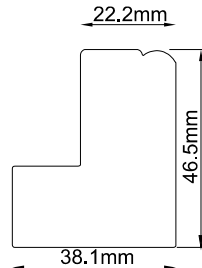

50mm

CROWN Z FRAME

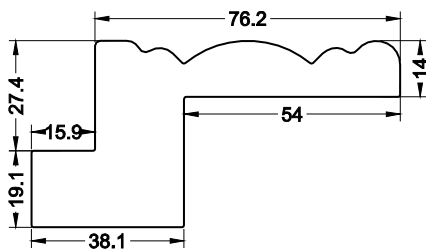

76mm

CROWN Z DEEP

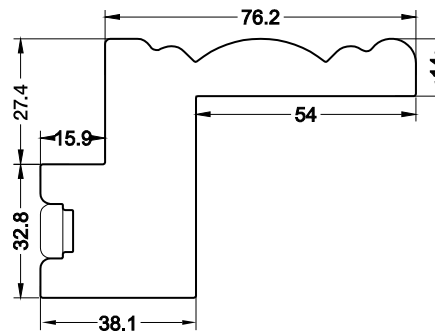

76mm

CROWN Z SILL PLATE

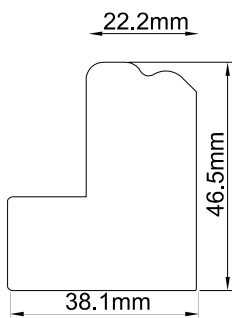

BEADED Z

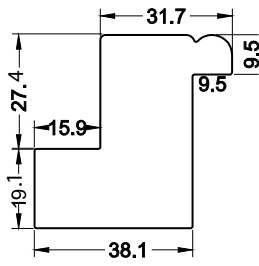

31mm

BEADED Z SILL PLATE

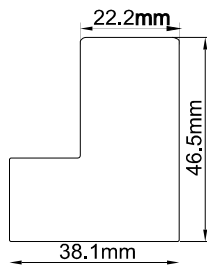

BULLNOSE Z

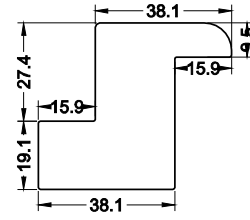

38mm

BULLNOSE Z SILL PLATE

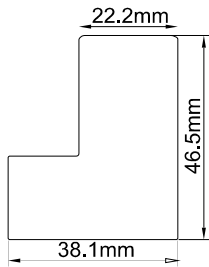

BULLNOSE Z DEEP W/INSERT

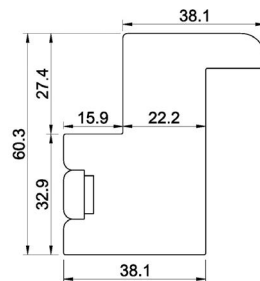

38mm

BULLNOSE Z FRAME

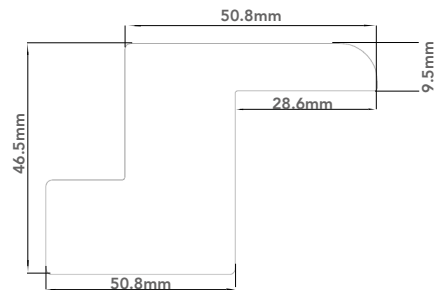

50mm

RIDGE DECO FRAME

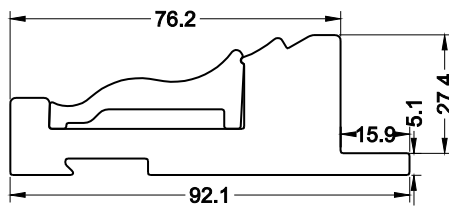

76mm

RIDGE DECO SILL PLATE

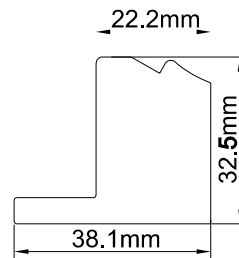

SERRATE Z FRAME

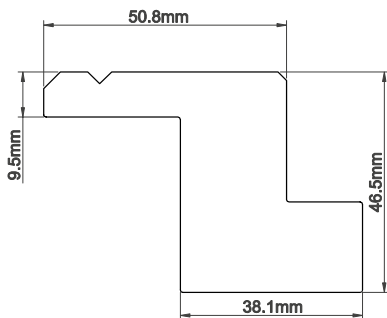

50mm

SERRATE Z SILL PLATE

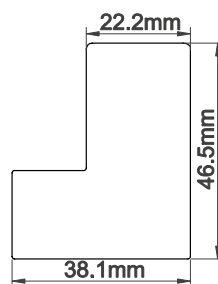

46mm

PLAIN DEEP L W/INSERT

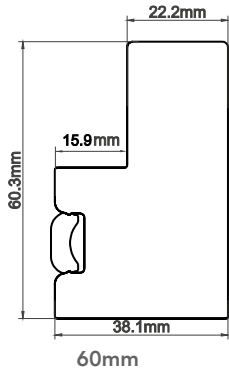

PLAIN L FRAME

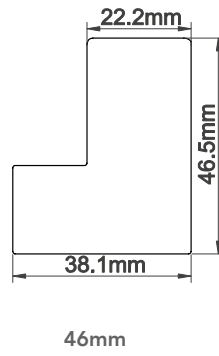

TIARA Z FRAME

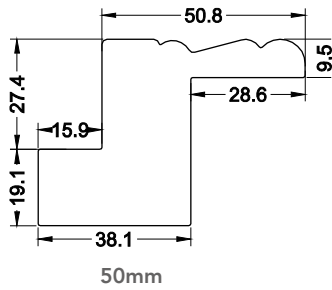

TIARA Z SILL PLATE

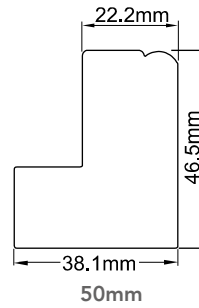

CROWN Z FRAME

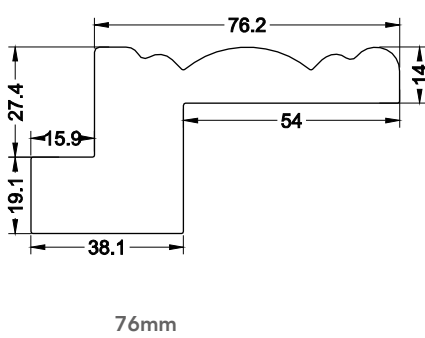

CROWN Z SILL PLATE

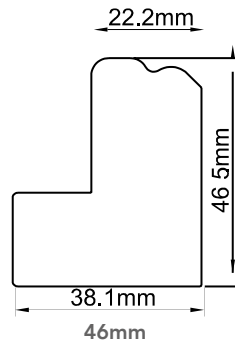

MISSION FRAME

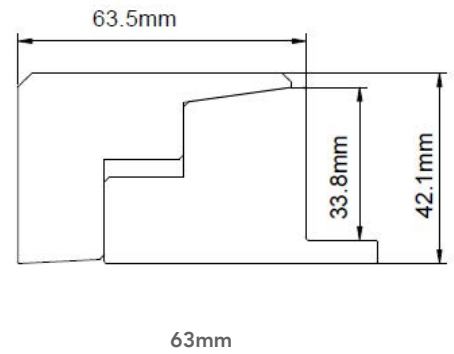

CAMBER DECO FRAME

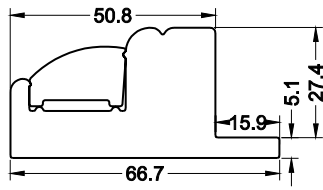

50mm

CAMBER DECO SILL PLATE

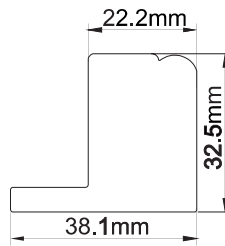

HANG STRIP WITH INSERT

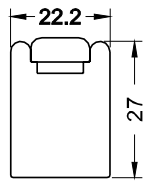

27mm

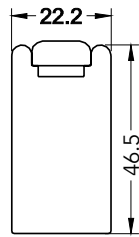

46mm

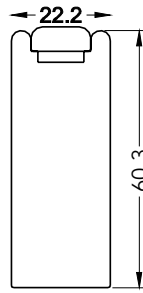

60mm

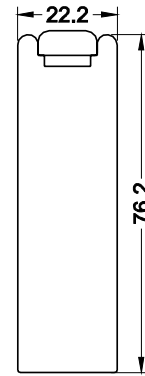

76mm

DOUBLE INSERT F FRAME (Only to be used for Shutter and Shade applications)

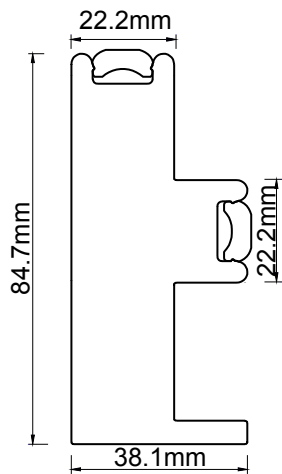

Double Insert F Frame
84mm

COVER STRIP*

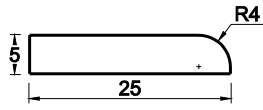

25mm

COVER STRIP*

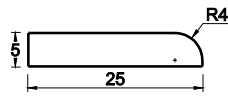

15mm

* Cover strips are made in wood.

T-POST

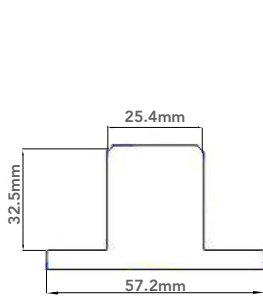

Chamfer T Post (Deco)

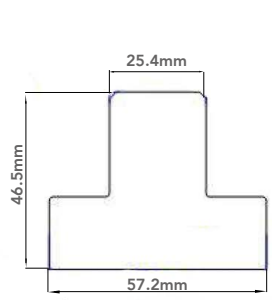

Chamfer T Post (L/Z/HS)

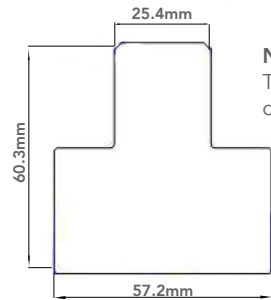

Chamfer T Post 60mm

NB. Please note that horizontal T Posts over 1219mm are not covered by warranty.

INSERT T

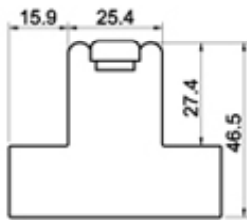

46mm

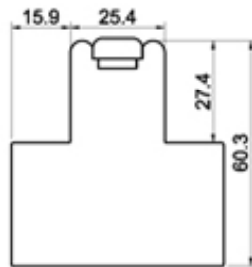

60mm

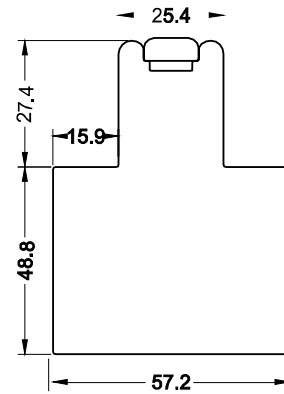

76mm

NB. Please note that horizontal T Posts over 1219mm are not covered by warranty.

CORNER POST

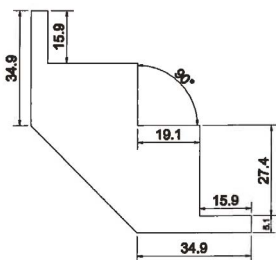

(Deco Frame)
32mm

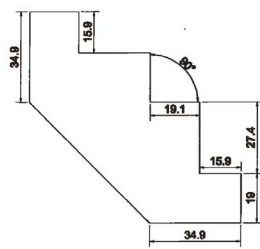

(L/Z/HS Frame)
46mm

BAY POSTS

Additional custom angles are also available in all materials.

135° angle

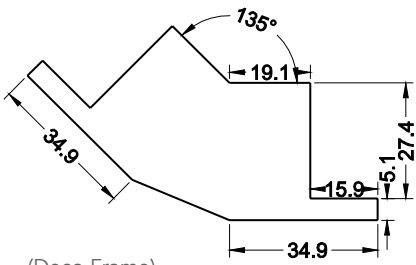

(Deco Frame)

32mm

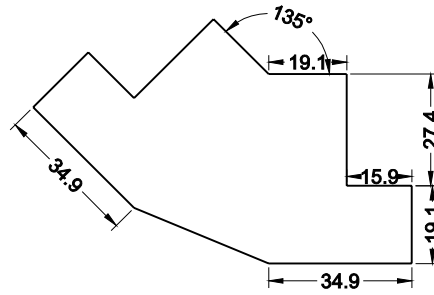

(L/Z/HS Frame)

46mm

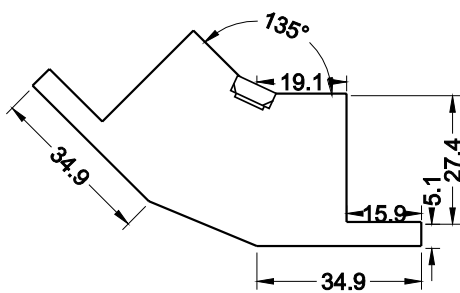

(Deco Frame)

32mm with insert

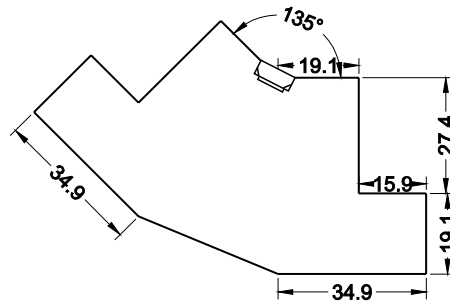

(L/Z/HS Frame)

46mm with insert

BATTENS

Battens can be butt-jointed as per the drawings below:

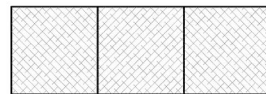
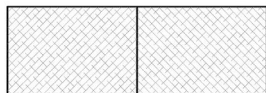

Standard sizes:

Stock Battens are available in the following sizes in all materials

Made of Wood	Coated with PP
2.5mm x 27mm	25mm x 30mm
3mm x 15mm	25mm x 40mm
3mm x 20mm	5mm x 38mm
3mm x 30mm	10mm x 38mm
3mm x 60mm	15mm x 38mm
5mm x 45mm	20mm x 38mm
5mm x 63.5mm	20mm x 38mm
30mm x 40mm	30mm x 38mm
40mm x 40mm	35mm x 38mm
	40mm x 38mm

Minimum charge one linear meter per batten

Battens and Panels identification: The order number will be stamped on the bottom of each panel and one end of each corresponding batten to identify which one belongs to which item.

Build-out (Extension)

- For L/Z/Deco/Hang Strip Frame including T-Post, we will pre-attach the build-out of which the thickness is less than 50.8mm (including 50.8mm) by default;
- For L/Z/Deco/Hang Strip Frame including T-Post, when build-out is over 50.8mm, we will supply build-out loose with holes pre-drilled; also note that for frame not able to pre-drill holes, such as Beaded L Frame, we will supply build-out loose without holes pre-drilled, either.
- For all frames, we will add build-out per the order form. E.g., if the frame type is 76mm L Frame, and build-out is 10mm, we

will use 76mm L Frame added with 10mm build-out instead of changing the frame type to mm L Frame added with 36mm build-out. For bay/corner Post, we will supply build-out in every size pre-attached by default.

- Extension for Z Frame: If you want the timber to be added to bottom of Z frame like the drawing below on the right, please ALWAYS specify in the special note of the order form, "Add extension to light block section". The DEFAULT EXTENSION will be the left drawing.

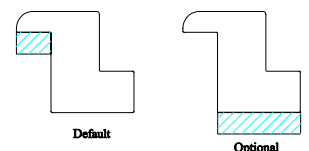

4. PANEL DETAILS

STILES

Flat

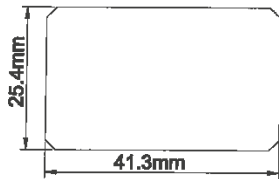

41.3mm Butt Stile

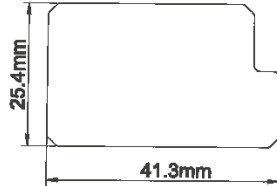

41.3mm Rebate Stile

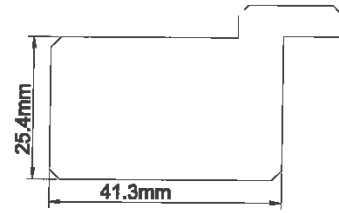

41.3mm Astragal Stile

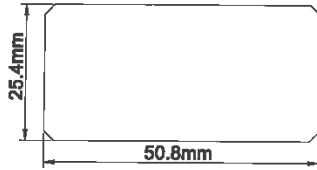

50.8mm Butt Stile

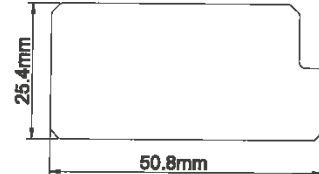

50.8mm Rebate Stile

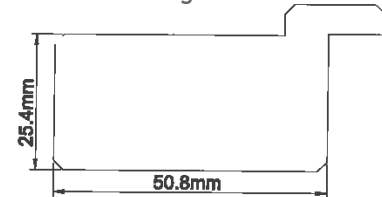

50.8mm Astragal Stile

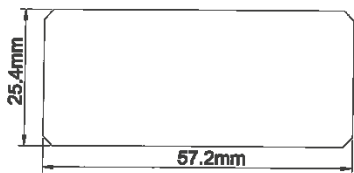

57.2mm Butt Stile

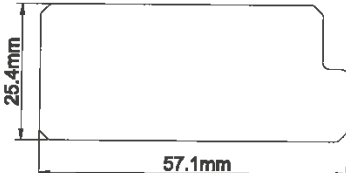

57.2mm Rebate Stile

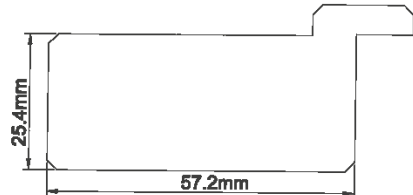

57.2mm Astragal Stile

Beaded

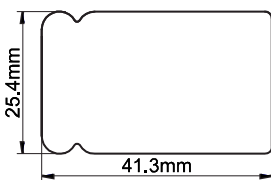

41.3mm Butt Stile

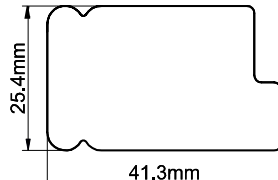

41.3mm Rebate Stile

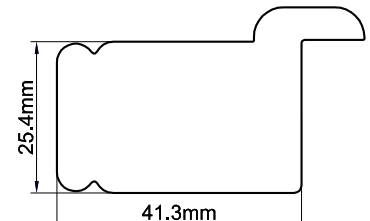

41.3mm D-Mould Stile

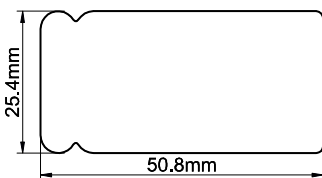

50.8mm Butt Stile

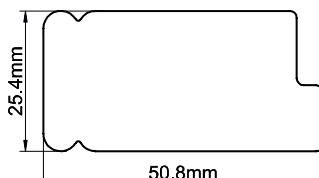

50.8mm Rebate Stile

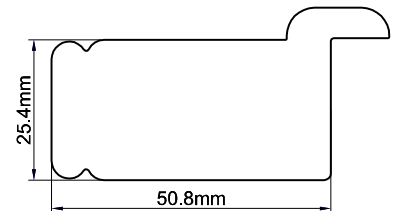

50.8mm D-Mould Stile

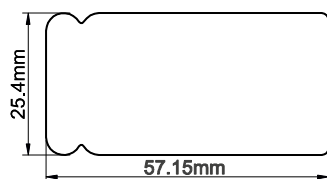

57.2mm Butt Stile

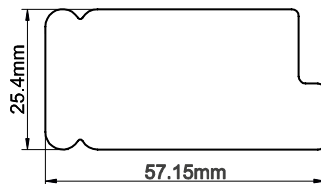

57.2mm Rebate Stile

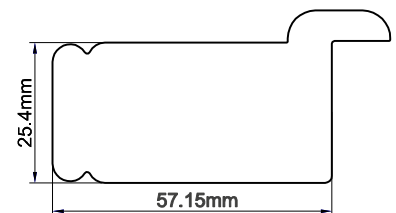

57.2mm D-Mould Stile

RAILS

The factory will decide the size, unless otherwise specified in the notes section on order form. The top and bottom rail will be the same size if there is no divider rail. If you need different size rails, please specify.

We suggest ordering shutters for the same customer at the same time, so that the rail sizes will match.

Please note the standard top/bottom rail sizes should be within 69.85mm~165.1mm.

For regular shutters, the step for the rail size is 3.175mm.



STANDARD MID-RAILS

The standard Mid-Rail size is 76.2mm high. Different mid-rail sizes can be requested though the combination of a fixed overall panel drop and louvre sizes means that it may not always be technically possible to fulfil every custom rail request.

If the panel height is greater than 1981mm one or more mid-rails are required. If the height from the centre of the mid-rail to the top of the top rail or bottom of the bottom rail is 1981mm or more, then another mid-rail is required. Mid-rail positions should be specified at time of ordering. If the order specifies that a mid-rail is not required then all warranties on the order are automatically waived.

PLEASE NOTE: Normally, the maximum size a mid-rail can be made is 165.1mm, anything over 76.2mm will carry a surcharge.

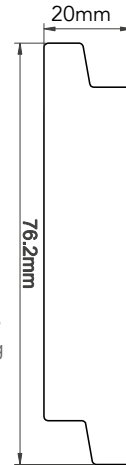

MID-RAIL continued

Specified rail position is taken from the base of the shutter set to the centre point of the rail, except for solid based which is from the bottom to the top of the mid-rail.

The centre rail can deviate by + or - by the amount of millimetres shown below. If the mid-rail is to be exact with no deviation then this must be noted on the order under the notes when placing the order.

Louvre Size	Allowable +/- Deviation
47mm	19mm
64mm	25mm
76mm	31mm
89mm	38mm
114mm	51mm

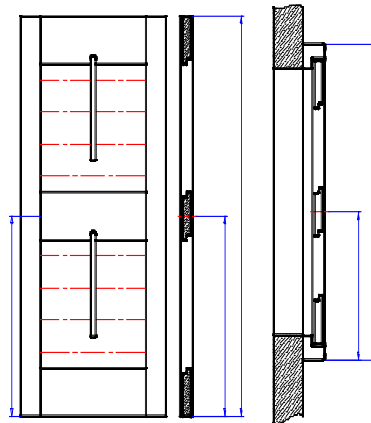

SOLID PANELS

Available in

- Raised panel with louver combination
- Raised panel only.

Specifications

- 304.8mm(12") < raised panel section height < 1219.2mm(48").
- Divider rail is required for panel heights over 1981.2mm(78").
- The maximum panel height is 3378.2mm (133").

Raised Panel Location(s)

- Top
- Middle
- Bottom
- All (if panel height does not exceed 1219.2mm(48").

Rails

- For a panel with raised panel section only, 76.2mm(3") is the standard size for top, bottom and divider rails.
- The minimum size for top and bottom rails is 76.2mm(3").
- If you are matching raised panels to standard shutter panels, the top rail of the standard shutter panel will match the top rail of the raised panel. Please specify clearly when placing order.

LOUVRES

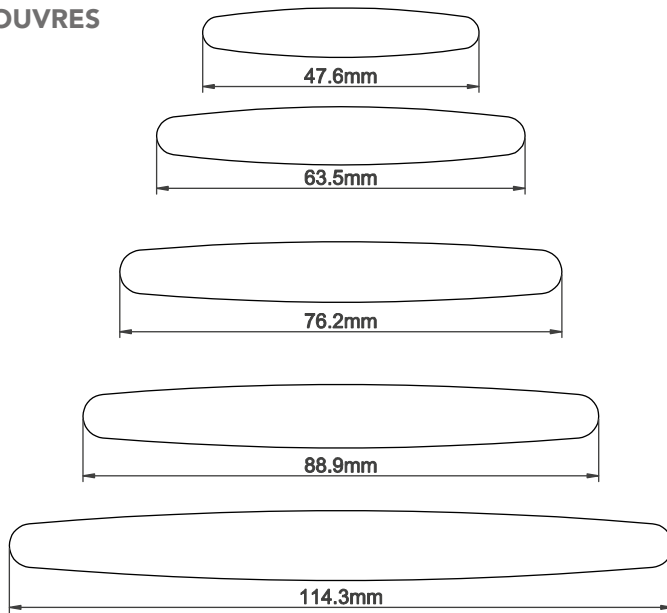

LOUVRE PIN

Louvre pins are used to ensure louvre tension. In addition a tension screw is inserted into one louvre in the panel. This is the same for all louvre sizes. Access holes are drilled in the in the stile for each panel to allow the tightening or loosening of the tension screw, to adjust the louvre tension. Please note therefore additional holes will be visible in the stiles.

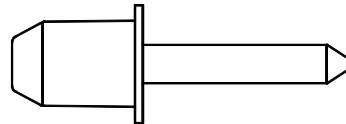

TILT RODS

Standard tilt rod

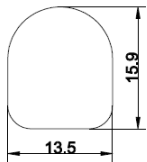

Silent tilt rod

Silent Tilt rods are integrated into the stile and are not visible. Silent tilt rods are available in 63mm, 76mm, 89mm and 114mm louvres. The 47mm does not have this option.

The Silent Tilt rod will automatically be split into 2 parts when the number of louvres connected to the silent tilt rod exceeds the following limit.

Louvre Size	Max Possible Louvres	Panel Height Range
63mm	24	1289 - 1385mm
76mm	19	1276 - 1372mm
84mm	16	1289 - 1385mm
114mm	12	1289 - 1385mm

If the louvre quantity exceeds the above limit, the gear tilt control will be equally split into halves. If the louvre quantity is odd the bottom section will have one more louvres than the top section. If the panel has a divider rail, and the louvre quantity above divider rail or below divider rail exceeds the above limit, split tilt rods are also required. Silent tilt is not available when the panel width is less than 220mm.

OFFSET TILT RODS

Offset tilt rods can be ordered. The standard offset is 25mm from the centre of the tilt rod to the end of louvre on hinge side. If a different offset is required please specify the position from the centre of the tilt rod to the end of the louvre on the hinge side in the short notes on the order form.

The centre of the tilt rod will be 25mm from louvre end on hinge side of the panel. For Fixed panels, the offset tilt rods will be positioned on the left side for all panels. For special shaped panels, the offset tilt rods will be on the higher side of the stile.

OFFSET TILT ROD FOR MULTI-FOLD SHUTTERS

Multi-fold panels will be made with the tilt rod offset from the centre to enable panels to be folded flat without tilt rods obstructing one another. The standard offset for the tilt rod is 7mm from the centre, i.e. tilt rod will be 7mm to the left of centre for left panels, and 7mm to the right of centre for right panels. Rebates between panels are made right over left. Bi-Fold panels (LR or LLRR) do not require offset tilt rods.

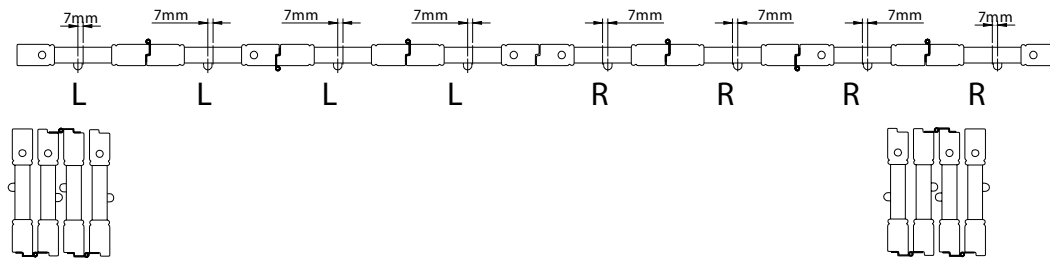

ROOF SHUTTERS

Shutters to be installed in an angled or horizontal skylight window opening, please specify on Gateway order form

Available Material	Wood shutters
Available Frame Type	Frame with light block thickness not less than 3/4"
Max Panel Size	660mm W x 1981mm H
Tilt Rod	Easy tilt
Panel Configuration	Single panel or single panels with T-Posts
Hardware for unhinged side	Barrel bolt/ security bolt/ roof catch on top and bottom + 2 button catches

5. ROOM DARKENING SHUTTER & SHADE

[BACK TO MENU](#)

SPEC020-2019

ROOM DARKENING BLIND OPTION

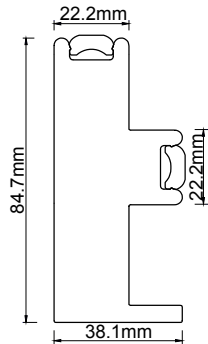

Double Insert F Frame
84mm

*NOTE: When you order Room Darkening blinds and the frame has a T post please note the defaulted specification below:

- If there is no build out with T post, then the Room Darkening blind will be defaulted to one blind sitting behind the T post.
- If there is build out with T post then the Room Darkening blind will be split according to the T post.

2. Frame mounting:

Outside Mount

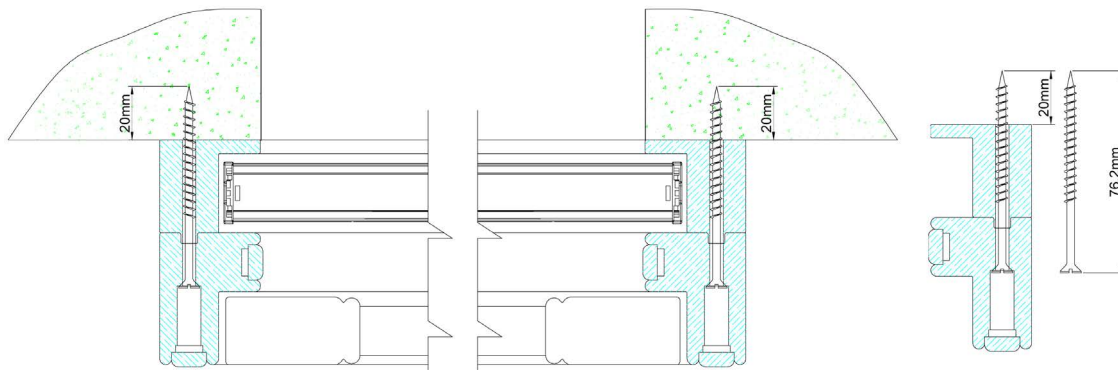

Inside Mount

Will require a minimum depth clearance 30mm.

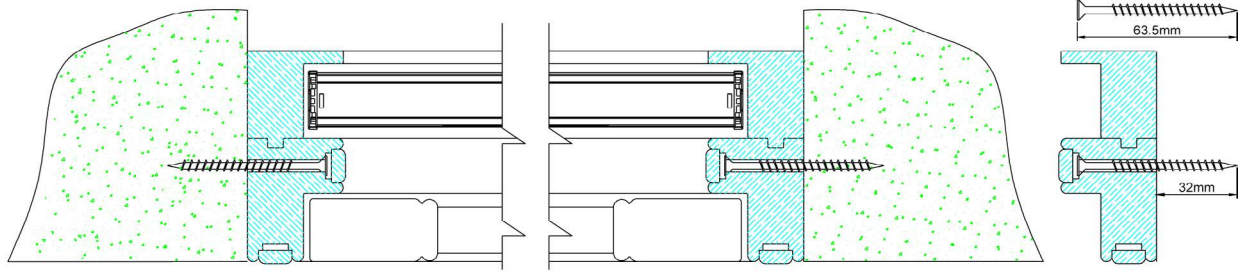

3. Number of frames:

3 sided (top, left & right) and 4 sided.

4. Available shutters:

All rectangular shutters.

5. Available cellular shade:

25mm corded system cellular shade-room darkening.
Pull cord is defaulted to the right side.

* The cord cleat will be on the light block between the shutter and shade.

6. Size limit:

	Min. Size	Max. Size	Max. Area
Width	220mm	2500mm	5.5m ²
Height	250mm	3600mm	5.5m ²

* The above chart does not mean that a shade can be ordered in maximum width and maximum height.

* The shade width and drop must be within the size limitations above and not exceed max area.

7. If there is a T post, Corner/Bay post, it will be made as below:

1). If the shade behind is for one whole piece, the post and frame will be joined as illustrated below: (Take the T post for example).

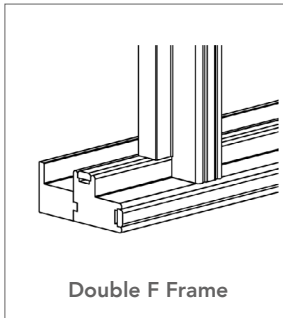

2). If the shade behind is divided into several pieces by the T post, Corner/Bay post, then T post, Corner/Bay post needs additional 33.2mm (Double F Frame) build out at the back for the standard frame depth. See illustration below:

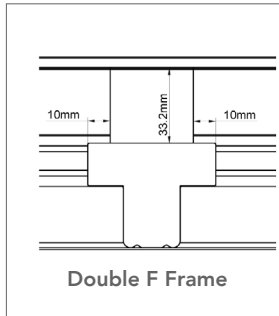

For Corner, Bay post, take Double F frame as example:

Corner Post With Build Out

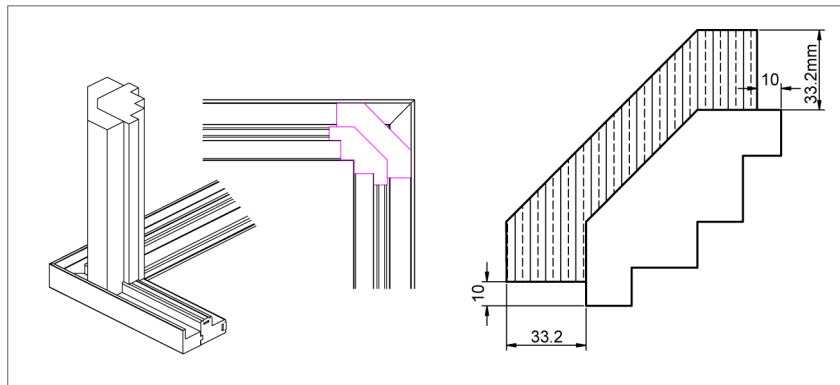

Bay Post With Build Out

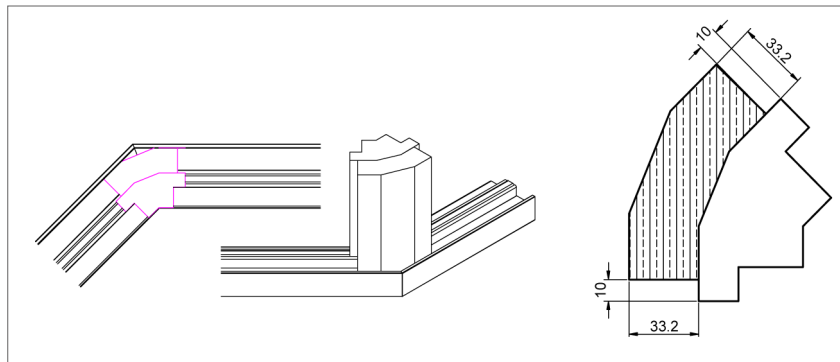

3). For Double F frame with T post, the insert for the Double F frame will be cut at the bottom of posts and there is 3mm overlap between insert and post. . See illustration below:

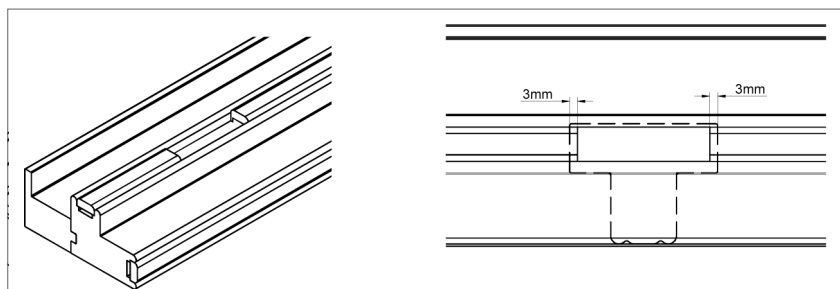



ROOM DARKENING BLIND STACKING HEIGHTS

Shade Height (mm)	Stacking Height (mm) Room Darkening	Shade Height (mm)	Stacking Height (mm) Room Darkening
254	39	1651	77.8
279.4	39.8	1676.4	78.6
304.8	40.6	1701.8	79.4
330.2	41.4	1727.2	79.8
355.6	42.2	1752.6	80.6
381	43	1778	81.4
406.4	43.8	1803.4	82.2
431.8	44.6	1828.8	83
457.2	45.4	1854.2	83.4
482.6	45.8	1879.6	84.2
508	46.6	1905	85
533.4	47.4	1930.4	85.8
558.8	48.2	1955.8	86.2
584.2	49	1981.2	87
609.6	49	2006.6	87.8
635	49.4	2032	88.6
660.4	50.2	2057.4	89.4
685.8	51	2082.8	89.8
711.2	51.8	2108.2	90.6
736.6	52.6	2133.6	91.4
762	53.4	2159	92.2
787.4	54.2	2184.4	93
812.8	54.6	2209.8	93.4
838.2	55.4	2235.2	94.2
863.6	56.2	2260.6	95
889	57	2286	95.8
914.4	57	2311.4	96.6
939.8	57.8	2336.8	97
965.2	58.6	2362.2	97.8
990.6	59	2387.6	98.6
1016	59.8	2413	99.4
1041.4	60.6	2438.4	100.2
1066.8	61.4	2463.8	100.6
1092.2	62.2	2489.2	101.4
1117.6	62.6	2514.6	102.2
1143	63.4	2540	103
1168.4	64.2	2565.4	103.4
1193.8	65	2590.8	104.2
1219.2	65.8	2616.2	105
1244.6	66.2	2641.6	105.8
1270	67	2667	106.6
1295.4	67.8	2692.4	107
1320.8	68.6	2717.8	107.8
1346.2	69	2743.2	108.6
1371.6	69.8	2768.6	109.4
1397	70.6	2794	110.2
1422.4	71.4	2819.4	110.6
1447.8	72.2	2844.8	111.4
1473.2	72.6	2870.2	112.2
1498.6	73.4	2895.6	113
1524	74.2	2921	113.8
1549.4	75	2946.4	114.2
1574.8	75.8	2971.8	115
1600.2	76.2	2997.2	115.8
1625.6	77	3022.6	116.6

Stacking height schedule: Please note stacking height is just for your information not to the exact height.

**ROOM DARKENING BLIND
25MM COLOURS**

[BACK TO MENU](#)

Brie C4510

Sand C4508
<i>No colour image currently available</i>
Desert C4504

Primrose C4506
<i>No colour image currently available</i>
Tamarind C4507
<i>No colour image currently available</i>
Black Ink C4201

Dusk C4105
<i>No colour image currently available</i>
Steel Grey C4101
<i>No colour image currently available</i>
Infinity C4108
<i>No colour image currently available</i>
Champagne C4111
<i>No colour image currently available</i>

Mineral C4108
<i>No colour image currently available</i>
Pebble C4509
<i>No colour image currently available</i>
Indigo C4704
<i>No colour image currently available</i>
Fog Green C4601

Slate C4104
<i>No colour image currently available</i>
Terra C4102

Topaz C4705
<i>No colour image currently available</i>
Glacier White C4001

Ecru C4412
<i>No colour image currently available</i>

6. HARDWARE

Hinges:

Rebate or Self-Mortice hinges are provided depending on the configuration. They are pre-mounted on panels and frames by two screws in the slotted holes. The screw for the third rest hole should be installed at installation. The hinge pins are removable.

Hinge Colours

Antique Brass, Bright Brass, Black, Nickel Plated, Stainless Steel (Surcharge), Brushed Nickel Plated (Surcharge), White, Pearl, Bisque, Pure White

Please Note:

Centre of hinge to top/bottom of panel is 76mm.

For the Fiji program

Panel height	No. of hinges
<=1219mm	2
1219mm~1981mm	3
1981mm~2438mm	4
2438mm~3048mm	5
>3048mm	6

MAGNETS

Round magnets are pre-mounted on the panels and the catch is pre-mounted on the frame when the order is 'OD' type. An 'L' shaped magnet catch is included in the hardware box when ordering 'OP' type.



CATCHPLATE



MAGNET

HANDLE OPTIONS

Handle A and B are available to order in Nickel Plated only. Please specify the handle you require along with the quantity on the notes section of your order card, they will not be pre installed but supplied loose in the hardware box. (Surcharge will apply).



Handle A

Handle B

HOFFMAN KEYS

These are supplied and are used to join frame corners together.



PANEL FEET

Panel feet are mounted on the bottom of panels when ordering 'OD' type and are included in the hardware box.

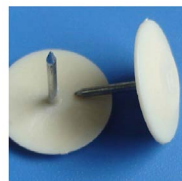

L SHAPE MAGNET CATCH

When ordering 3 sides frames with the gap more than 2.5mm, we will supply L shape magnet catch.



SIDE MAGNETS

This option is available in the order card and when selected we will add a magnet situated to the side of stile (1). It can be selected where a Left and Right panel meet where there is no lightblock or bottom frame to secure the panels. The magnets will act to keep the panels together.

Side magnets are available for butt, rebate and D-Mould stile, not available for the Java product.



(1) Magnet shown in side of stile



(2) Magnet keeping panels together

The side magnet can be selected where you have:

- a) Door shutters that require bottom clearance.
- b) Tier on Tier shutters without horizontal T post.
The side magnet will be installed on the top of the bottom tier and the bottom of the top tier (3).
- c) Café style shutters with upside down goal post frame (4).
- d) Window that do not have a light block or bottom frame (5).

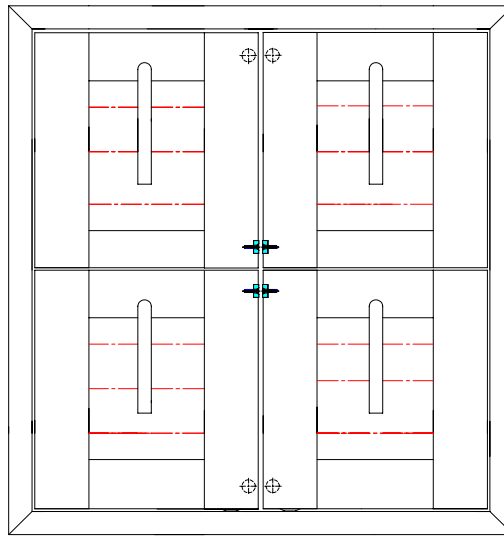

(3) Double Hung shutter without horizontal T post

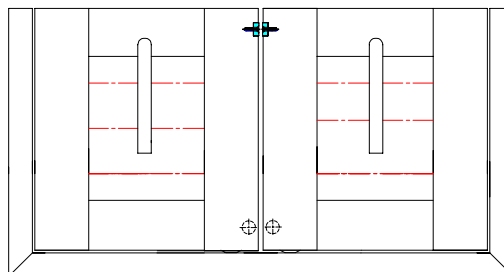

(4) Café Shutter

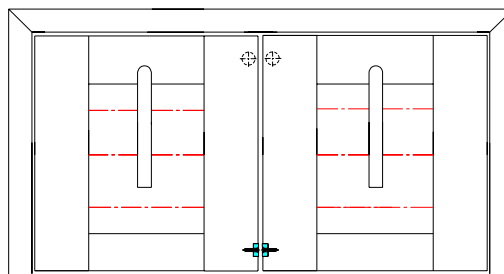

(5) No frame or light block on either top or bottom

BOLT & RING PULL



1. Barrel Bolt

Can be used for hinged shutter and Bi-fold track shutter to fit for panels. Based on the size of the bolt, 41.3mm stile cannot be used for this product.



2. Ring Pull

Can be used for hinged shutter and track shutter. Based on the size of the ring pull, 41.3mm stile cannot be used for this product. The location of the ring pull, refer to the bolt location.



3. Security Bolt

Can only be used for hinged shutter. Based on the size of the security bolt, 41.3mm stile cannot be used for this product. Please note you will need to note the location of the security bolt in the notes section of the order card.

RING PULL & BARREL BOLT

LL

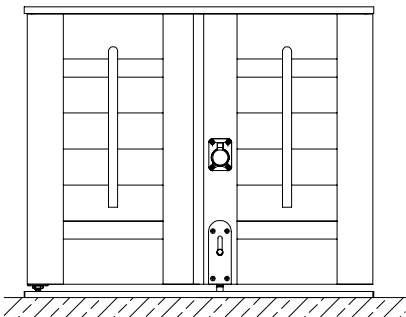

RR

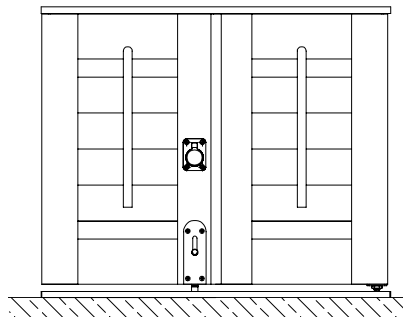

LLL

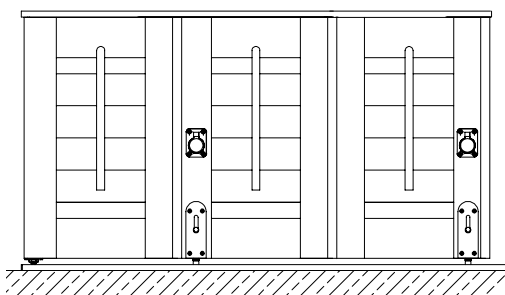

RRR

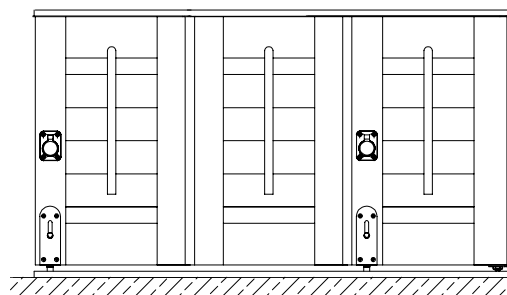

LLRR

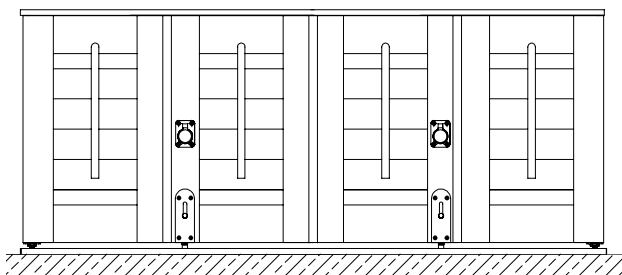

LLLL

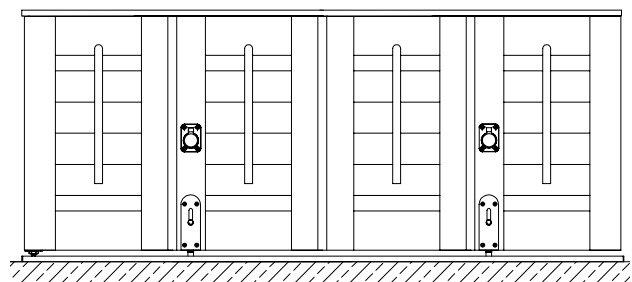

RING PULL & BARREL BOLT Cont.

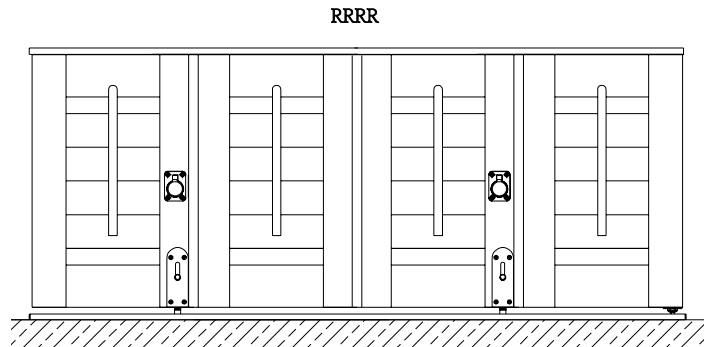

The bolt location for both track system shutters and regular shutters would be the same. The general principle is that the bolt position will avoid the stile which will install the spring-loaded guide at bottom (same stile as the Wheel carrier).

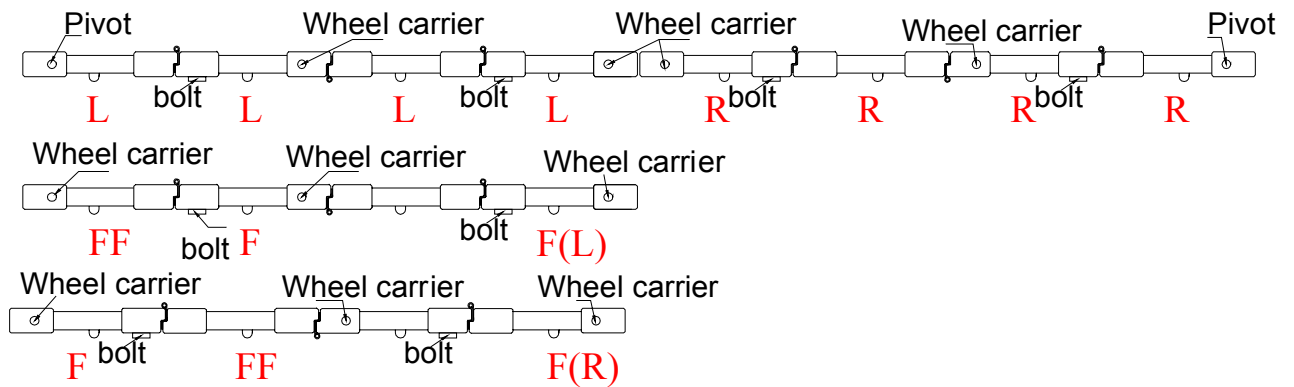

Ring pull: for easy opening and closing (Not available for 1.625" /47mm Stile)

Ring Pull and Barrel Bolt: Customer needs to specify ring pull location on the order form. Ring pull location principle for Floating Panels: (same as the location of 90° Bifold Track)

1. When floating panel config is in pairs, it will be split into halves, the left will be for LL and the right will be for RR. So the ring pull location for FF/FF, FF/FF/FF/FF will be same as that of panel config as LL/RR, LL/LL/RR/RR.
2. When floating panel config is FF, the ring pull location will be same as that of panel config LL.
3. When floating panel config is singular, it will be split into 3 sections, the left and mid sections are for LL and the right section is for RR. So the ring pull location for FF/FF/FF, FF/FF/FF/FF/FF will be same as that of LL/LL/RR, LL/LL/LL/RR/RR.

Please note the ring pull finish will match with the hinge finish.

Please see the matching chart below:

Hinge	Pure White	White	Bisque	Pearl	Black	Nickel	Brushed Nickel	Antique Brass	Bright Brass	Stainless Steel
Ring Pull	White	White	Bisque	Pearl	Black	Brushed	Brushed Nickel	Antique Brass	Bright Brass	Brushed Nickel

Position: For different panel configuration, please refer to the location of bolt to show on which stile the pull will be fixed.

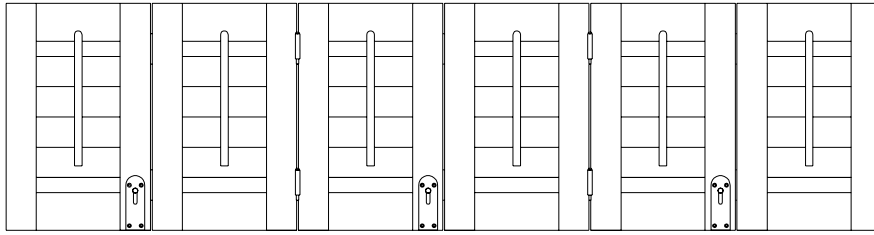

Panel Fold:FFFFF(L)

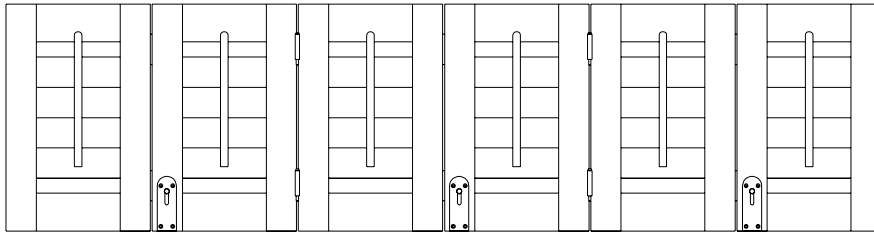

Panel Fold:FFFFF(R)

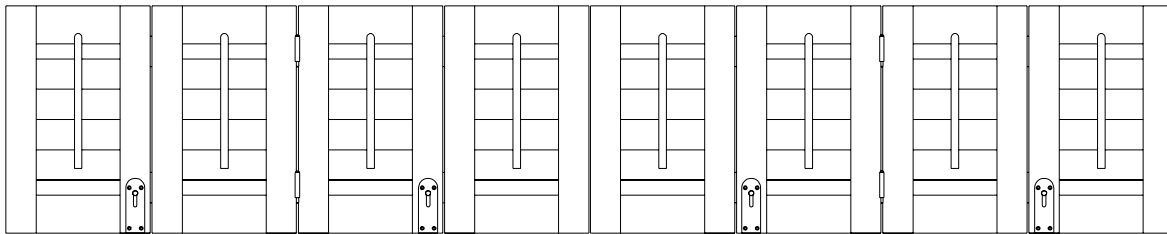

Panel Fold:LLLLRRR

NOTE

1. If bolt is requested on track system shutters, the bolt will be installed as per the above drawings.
2. The general principle is that the bolt position will not be on the panel, which has the spring-loaded guide at the bottom. That is to say, it will be on the right stile of the 1, 3, 5...odd number panels for L panel fold. It will be on the left side of 2, 4, 6...even number panels for R panel fold. (always count from left to right) see the fold below as example:

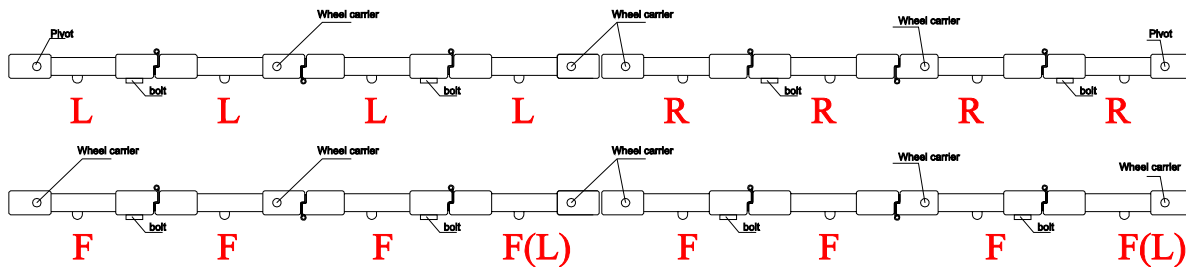

3. If both ring pull and bolt are required on the track system shutters, then, the ring will be on the same stile as bolt. When there is no mid rail, ring pull will be just on top of the bolt (70mm above bolt) as default location; if there is a mid rail, bottom of ring pull will line up with top of mid rail as default location.

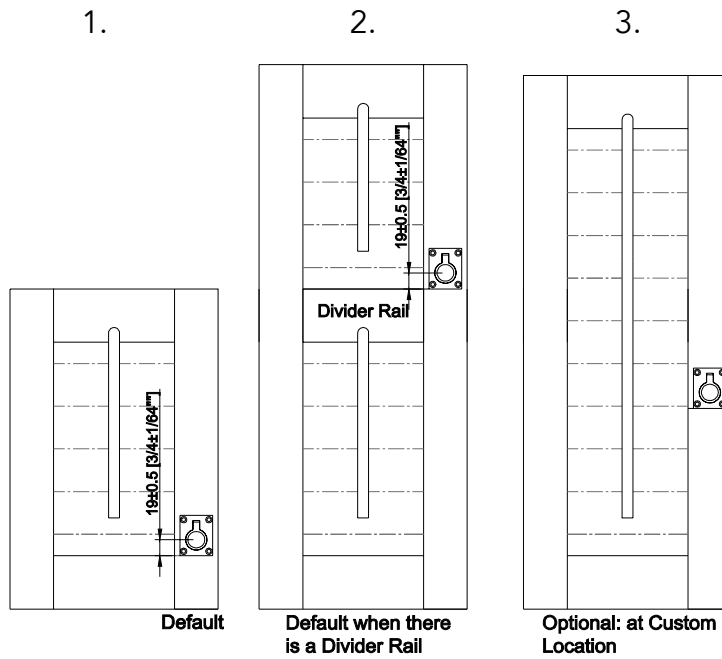

Position:

1. Above Bottom Rail (Default)
2. Above 1st Divider Rail (Default when there are Divider Rails)
3. Custom Location

If both bolt & ring pull are specified, the distance between them is 2 3/4" (70mm), and the ring pull location is 6 3/4" (170mm) from the bottom of panel.

When there is no mid rail, ring pull will be just on the top of Bolt (2 3/4" /70mm above bolt) as default location; if there are mid rails, bottom of ring pull lines up with top of the 1st mid rail as default location.

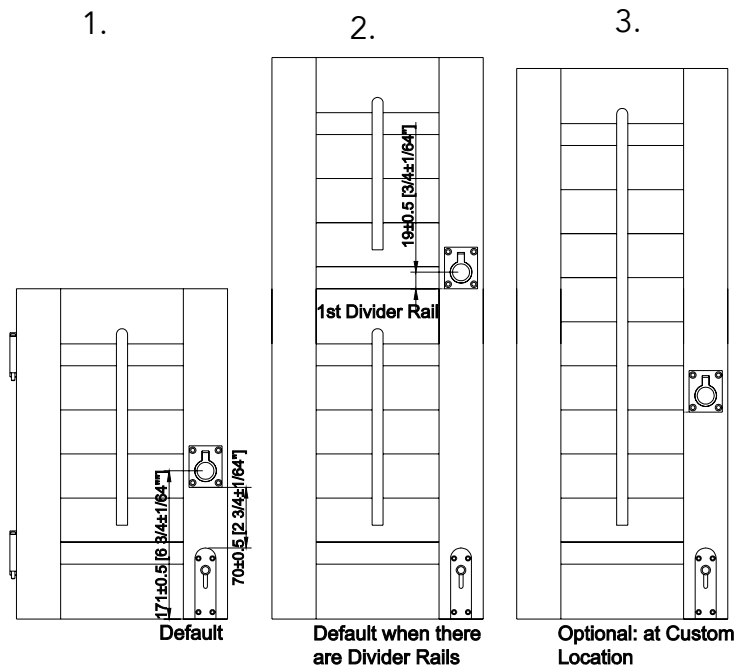

Position:

1. 2 3/4" (70mm) Above bolt (Default when both Ring Pull and bolt are specified)
2. Above 1st Divider Rail (Default when there are Divider Rails)
3. Custom Location

Measurements:

Window size: Measure from the bottom of the window to the centre of the ring pull

Max frame-to-frame: Measure from the bottom of the frame to the centre of the ring pull

PANEL CONFIGURATIONS

If you order shutters in OVERALL PANEL SIZE & OD OF FRAME, panel configuration is required.
 Please specify if the stile type required is Rebate or D-Mould.
 Please note Fiji is supplied with a flat stile.

1 panel: L/R

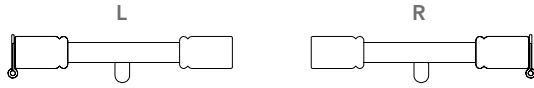

2 panels: LL/RR/LR

A) Rebate stile

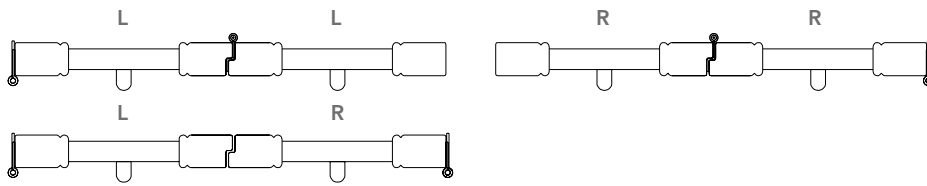

B) D-Mould stile

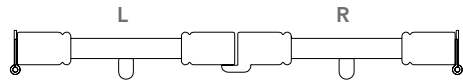

3 panels: LLR/LRR

A) Rebate stile

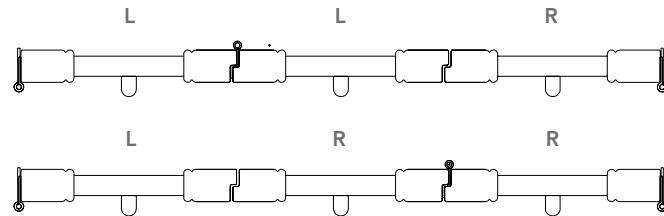

B) D-Mould stile

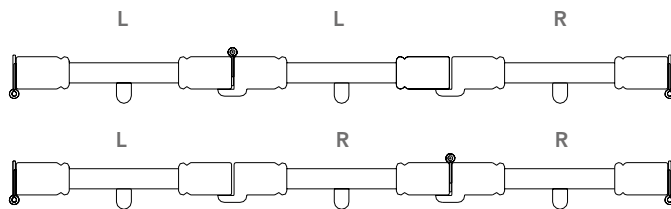

4 panels: LLRR

A) Rebate stile

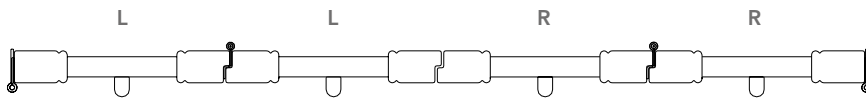

B) D-Mould stile

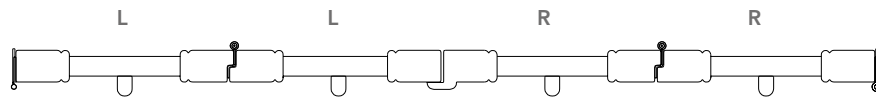

Offset tilt rod for multi-fold shutters

For multi-fold panels, we will place the tilt rod offset from the centre. By doing so, panels can be folded flat without tilt rods obstructing each other. The standard offset for the tilt rod is 7mm from the centre, i.e. tilt rod will be 7mm to the left from the centre for the left panels, and 7mm to the right from the centre for the right panels. Besides, the Rebate is made with right panels over left ones for both the panels folded to left and to right.

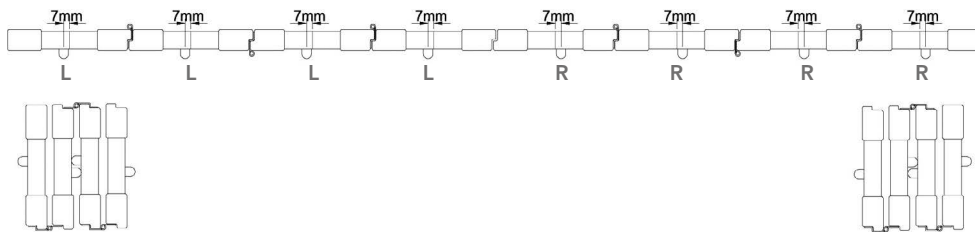

* For 2 panels (LL/RR) and 4 panels configuration (LLRR), there is no need to offset the tilt rod.

PANEL SIZE LIMITATIONS

Panel structure

The S:CRAFT shutter panel is made up of several parts. To help you understand the panel construction please see photograph.

MOUSE HOLE

STILE

TILT ROD

LOUVRE

RAIL

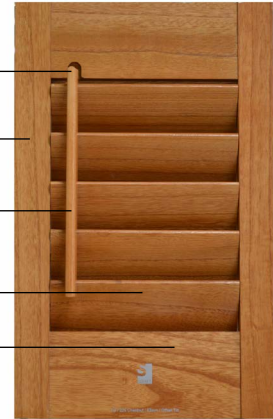

Louvre Size	Width				Height			
	Minimum	Maximum			Maximum number of untracked Multi-fold panels	Minimum	Maximum without mid rail	Maximum with mid rail
		Single hung	Bi-fold hinged shutter/ Multi-fold with Top and Bottom track	Multi-fold hinged shutters & multi-fold with Top track only. Number of panels ≤ 4				
47mm	152mm	750mm	660mm	550mm	4	250mm	1981mm	3000mm
64mm	152mm	890mm	660mm	550mm	4	250mm	1981mm	3000mm
76mm	152mm	890mm	660mm	550mm	4	250mm	1981mm	3000mm
89mm	152mm	1047mm	660mm	550mm	4	250mm	1981mm	3000mm
114mm	152mm	1047mm	600mm	550mm	4	250mm	1981mm	3000mm

NB: Where the panel size limits above are exceeded, warranty on the order line is waived automatically.

NB: When a single hung panel width is less than 228.6mm and used with the following frames: Deco, L, Z and Hang Strip, the stile opposite to the hinge will be rebated.

If panel height is over 1981mm, a Mid Rail is required and if the panel has a Mid Rail but the height from the centre of the Mid Rail to the top of the top rail or to the bottom of bottom rail is still over 1981mm, another Mid Rail will be required.

If you do not specify the Mid Rail location, the order will be held to confirm if a Mid Rail is required. However, if you specify no Mid Rail, you will waive your warranty and manufacture will proceed as per your instructions.

Shutter used for door without bottom support:

In situations where shutters are used for door applications, which do not have any support underneath the panels, the customers must inform S:CRAFT when placing this type of order. (See the following specs for Shutters used in Door applications)

Please note:

- (1) The factory will add extra hinges to support the panels.
- (2) Bigger and Stronger Top and Bottom rails will be added to reduce the probability of the panels sagging and increase shutter intensity.
- (3) If customers fail to notify S:CRAFT that the shutter will be used in door applications, the customers will be responsible for the cost of the any re-order that is submitted.

Please see the following chart for details.

Panel Configuration	
L,R,LR	LL, RR, LLRR
Manufactured with warranty	Must order it with track, we will not process it even with warranty waived

PANEL WEIGHT

Panel Weight		
Material	Louver size	Weight (kg)/m ²
Fiji	47mm	TBC
	63.5 mm	6.8
	76 mm	TBC
	88.9 mm	6.9
	114.3 mm	7.6

* Average Weight

FIXED LOUVRE OPTIONS

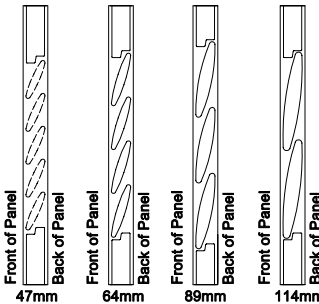
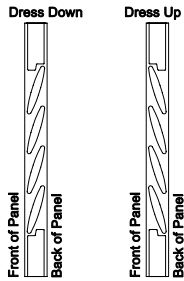
	Fixed Closed Position	Fixed Open Position
<p>Available in two positions: closed or open at angle.</p>		
<p>The standard default orientation for Fixed louvres is Closed 'Dress Down' with the bottom edge of louvres to the front of the panel. 'Dress Up' option is also available if specified on the order form.</p> <p>NB. Note that normal orientation for <i>adjustable louvres</i> when closed is in the 'Dress Up' state.</p>		

SPECIAL SHAPE SHUTTER OPTIONS

Other shapes available

Fan Top

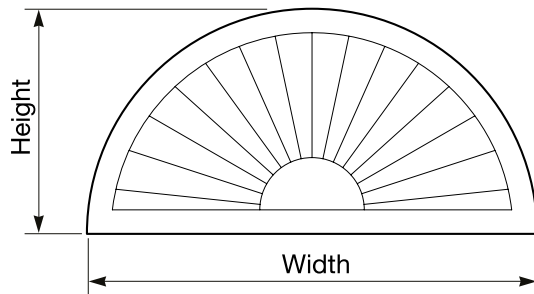

Louvre Arch

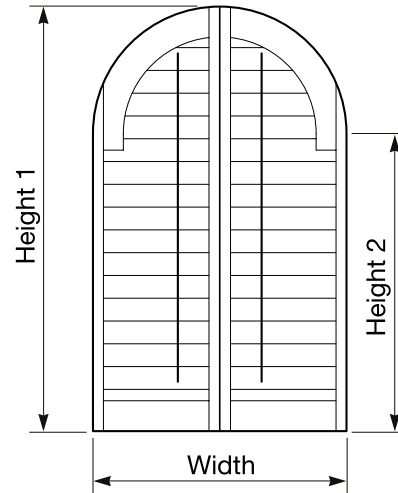

Tapered

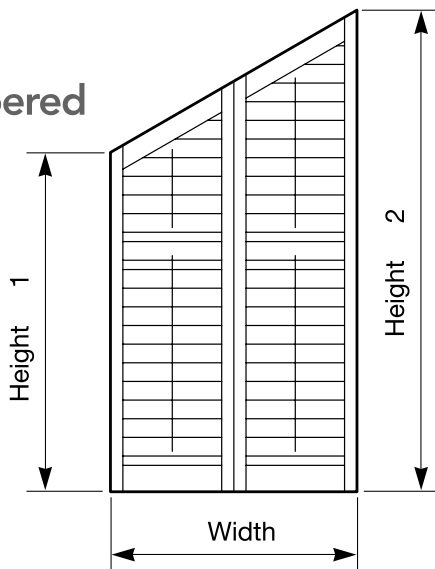

Circle

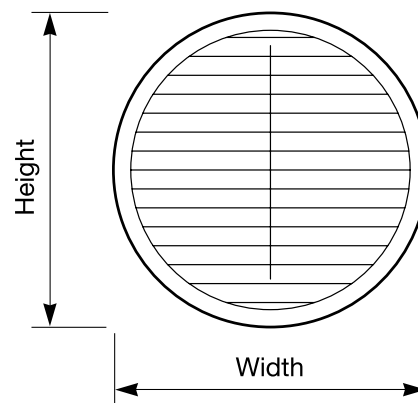

Templates

Inside recess fitting

A template is always required.

Outside recess fitting

1. For a perfect arch, template is not required.
2. If the shutter is an imperfect arch or any other shape, a template is required.

All templates should show the OD dimension of the shape required and state clearly which surface is the front.

For special shape shutters, S:CRAFT will produce a CAD drawing for distributor approval. Please check every dimension shown on the drawing to prevent any mistake or misunderstanding.

The distributor should approve and return this to S:CRAFT for production to commence.

NB.

- All special orders are on extended lead times and require an additional one week for manufacturing from approval of the drawings.
- Frames with insert strips will not have removable strips around curves.
- For angled or arched shutters the leg height must be more than 60% of the overall height to maintain warranty for the panels hinged to the leg frame.

7. SIZING AND MEASURING

ORDER SIZE DEFINITION

Overall Panel size (OP):

The size given is the overall panel size. The width does not include the hinge space from panel to batten on the left & right side, but does include the gap between panels, the standard gap is 2mm between panels and we will calculate the single panel width based on this measurement (see diagram below). The height given must be net panel height. We will pre-mount the hinges and the magnets and include panel feet and L shape magnet catches in a hardware box. The stile can be Rebate or D-mould, please specify in the relevant section of the order form.

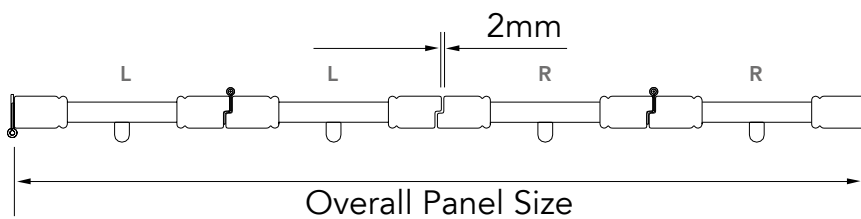

OD of frame:

Size given is "Outside Dimension" of the shutter; we will pre-mount the hinges and the magnets, and will include all the necessary hardware in a hardware box. The stiles can be Rebate and D-Mould stile, please specify on the order form.

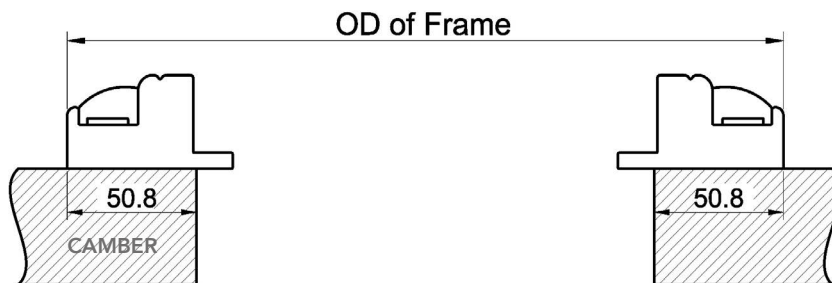

Camber Deco Frame 50mm: Can only be ordered as outside mount, the size given must be OD of frame size.

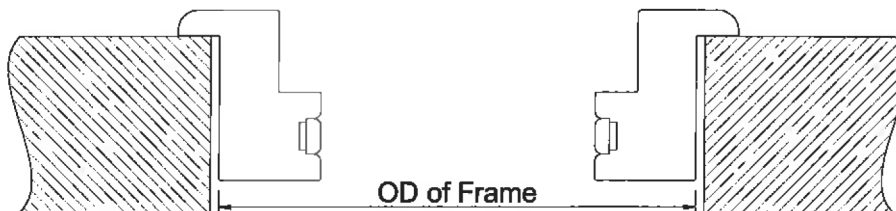

"Z" frame: Can only be ordered as inside mount, the size given must be OD of frame size. (Backside of Z frame, refer the drawings).

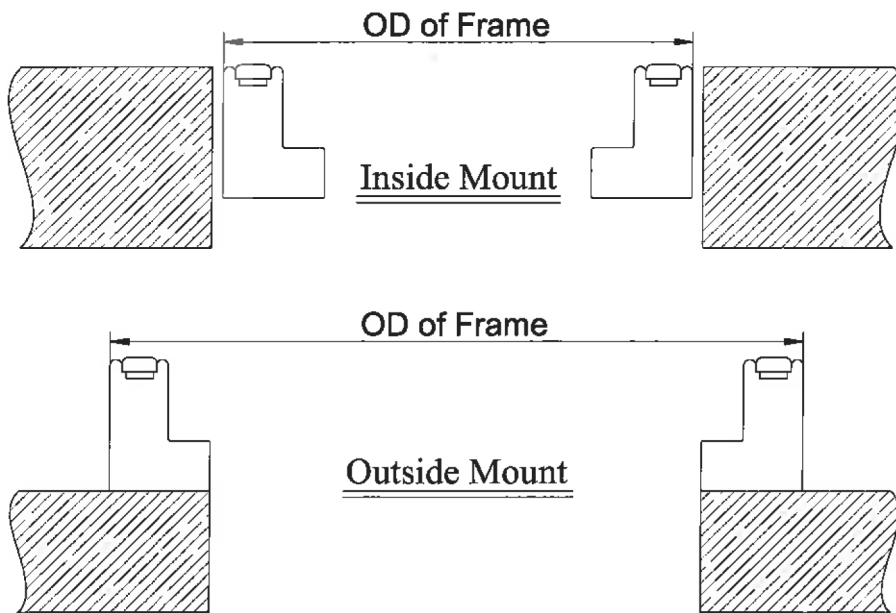

"L" frame: Can be ordered as inside mount and outside mount, size given must be OD of frame size.

TOLERANCES

Width: The width of the panel can be plus or minus 1.6mm from the order width.

Height: The height of the panels can be plus or minus 1.6mm from the order height.

Mid Rail location: Mid Rail location may be off by half a louvre space. Measure from bottom of bottom frame to centre of Mid Rail if order OD of frame, and from bottom of panel to centre of Mid Rail if order net panel size or overall panel size.

For 47mm louvre can be off by +/-19mm.

For 63mm louvre can be off by +/-25mm.

For 76mm louvre can be off by +/-31mm.

For 89mm louvre can be off by +/-38mm.

For 114mm louvre can be off by +/-51mm.

MOUNTING TYPE

Café style shutter: Please specify on the order form if the shutter is a café style. We will finish the top of the panels and one end of the battens.

If a café shutter is required with a 3 sided frame, it should be 3 sides inverted.

Tier on Tier: The standard gap between the top tier and bottom tier is 2.5mm.

Full height: Regular shutters running the full height of a window.